

**Pedestal Legs**  
Form into square tubes and insert into square slots in Pedestal Bottom, gray sides out

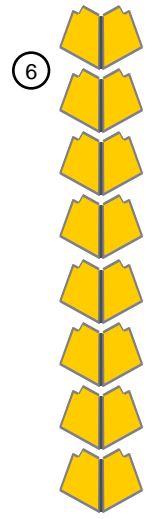

Hold Down Arms & Tail Service Arms  
Fold and Glue to white lines on Pedestal Cap.

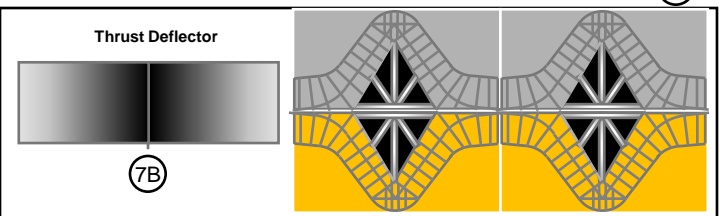
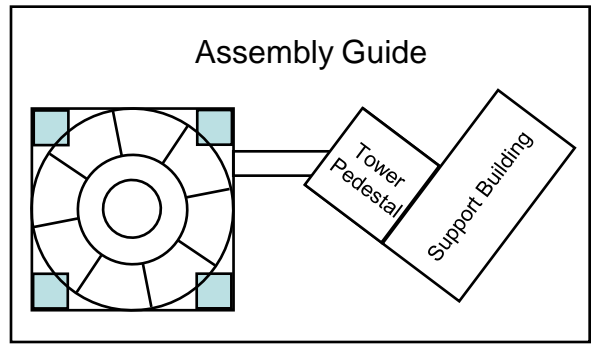
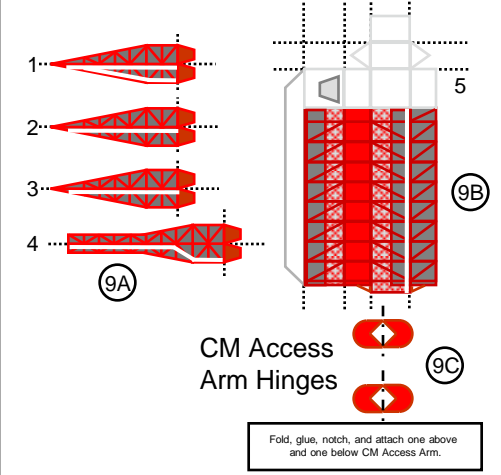
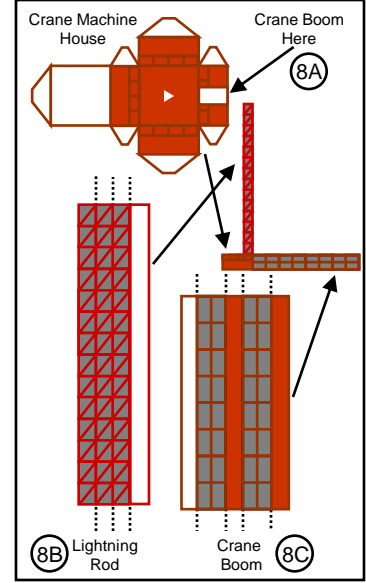

Apollo Historical Series  
Launch Complex 34  
Print to Cardstock

This square is glued on top of square tower base. See Assembly Guide

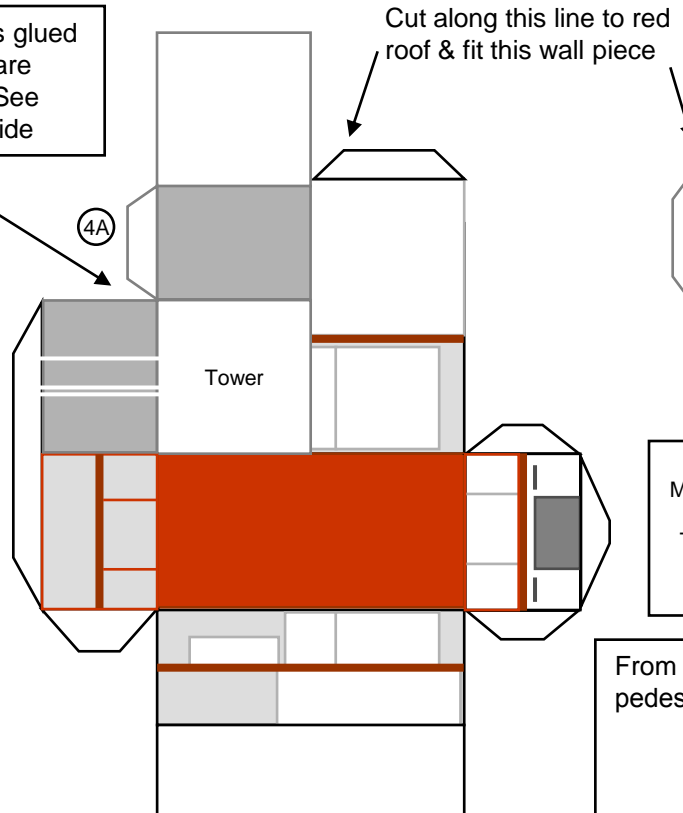

© 2010 Drawn by Michael Burke & George Blanchette  
This cardmodel is only for personal and not commercial use.

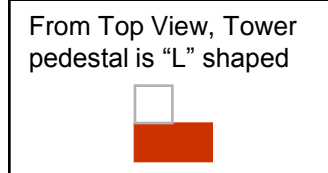

**Access Arm Hinges**  
Fold, glue, notch, and attach one above  
and one below each Access Arm.

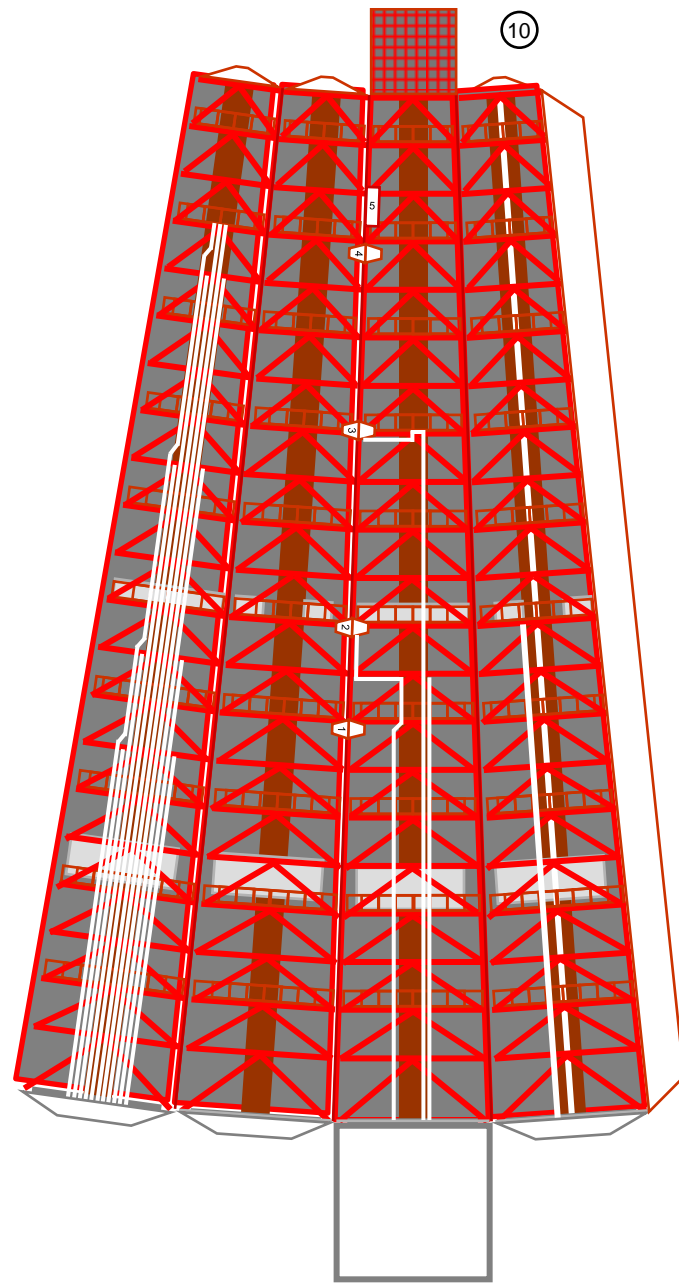
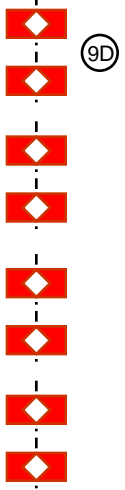

# Model Base – Option A

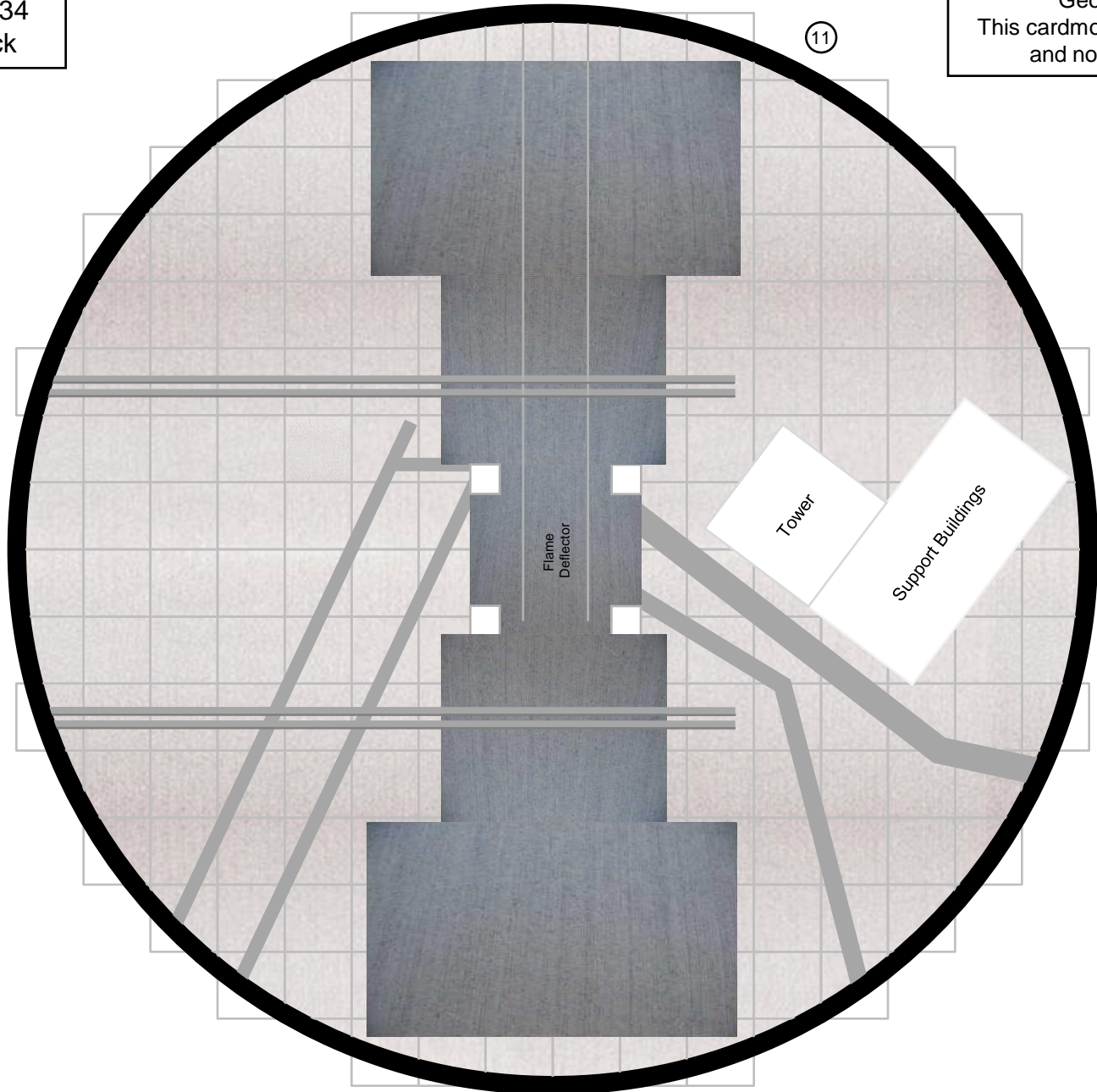

Recommend gluing to cardboard, wood, or other hard, flat surface

# Model Base – Option B ①①

© 2010 Drawn by  
Michael Burke and  
George Blanchette  
This cardmodel is  
only for personal and  
not commercial use.

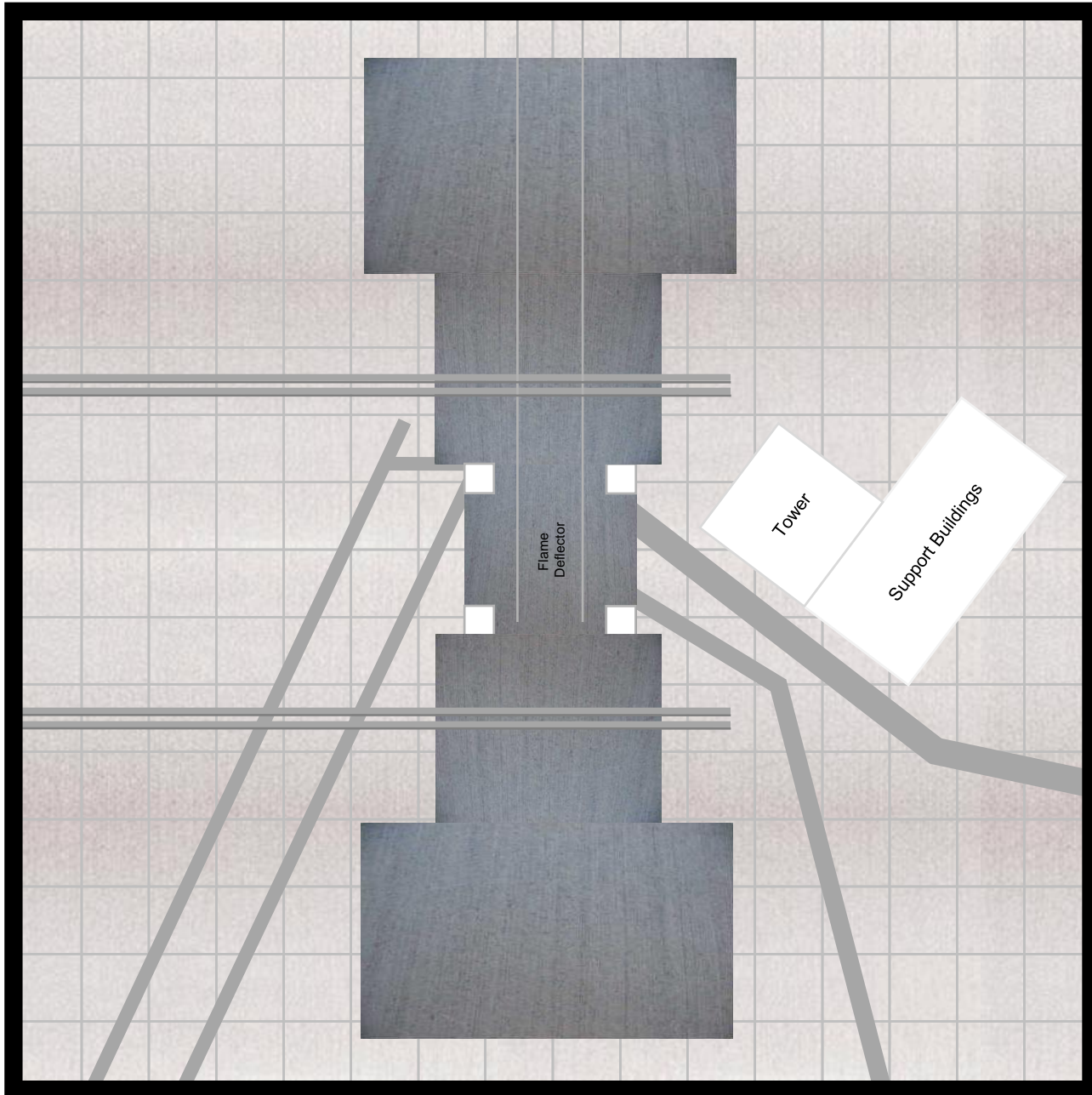

Recommend gluing to cardboard, wood, or other hard, flat surface