

Lunar Expedition Module

Project Energia-Vulkan

1:96 scale

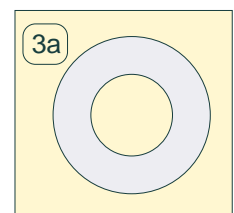
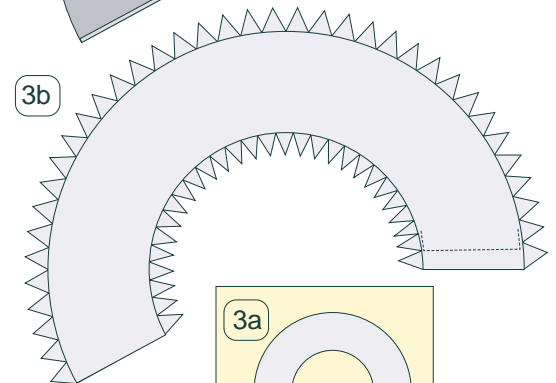
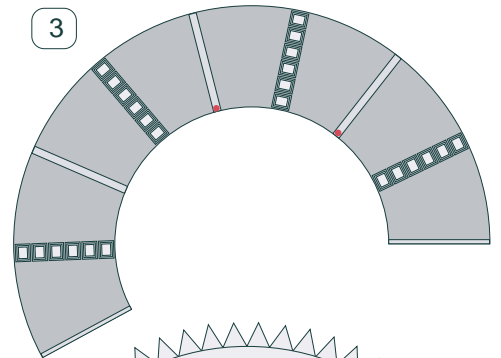
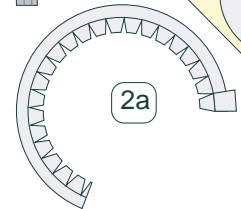
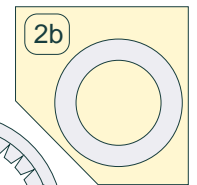
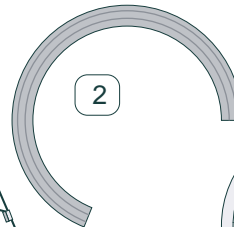
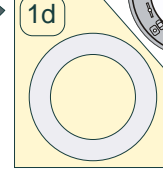
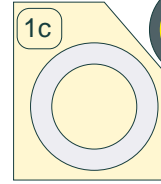
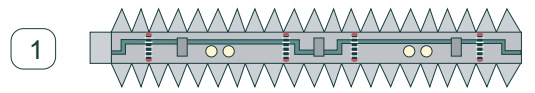
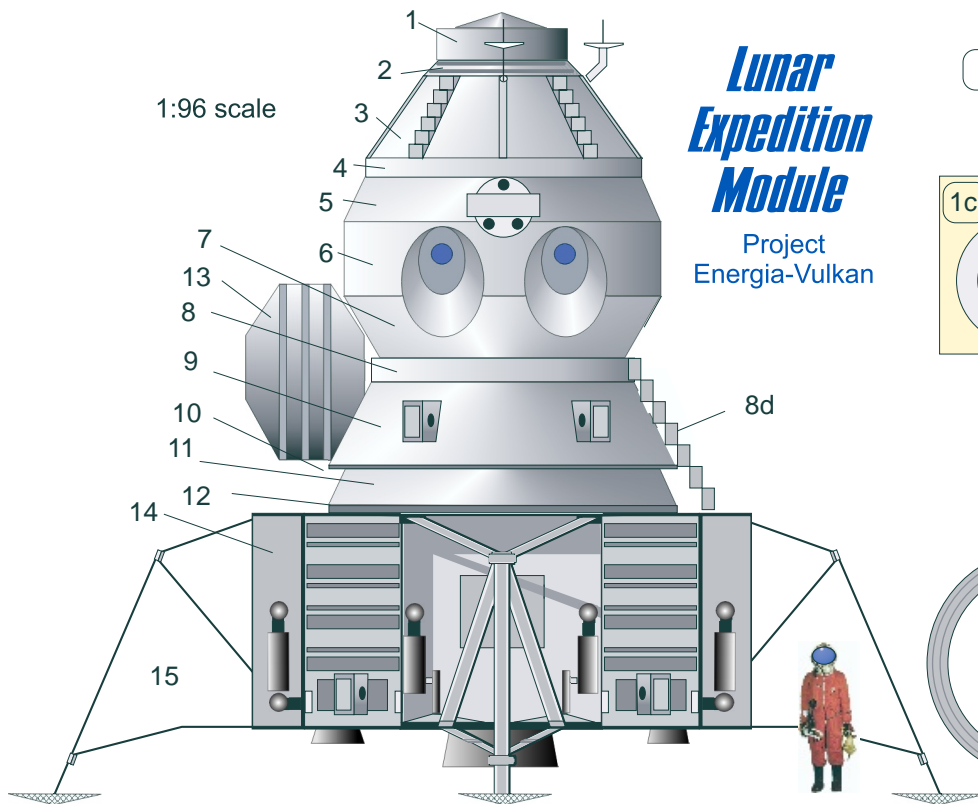

These parts glue onto same paper

These parts glue onto cardstock

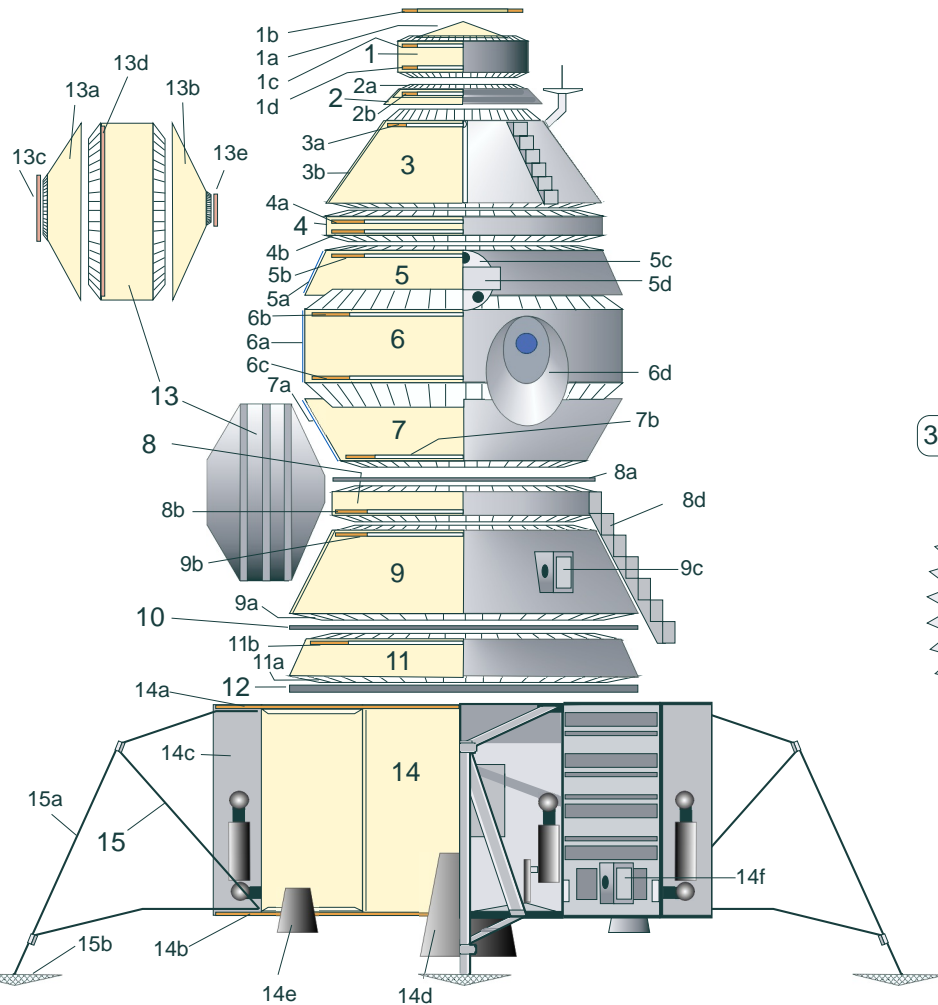

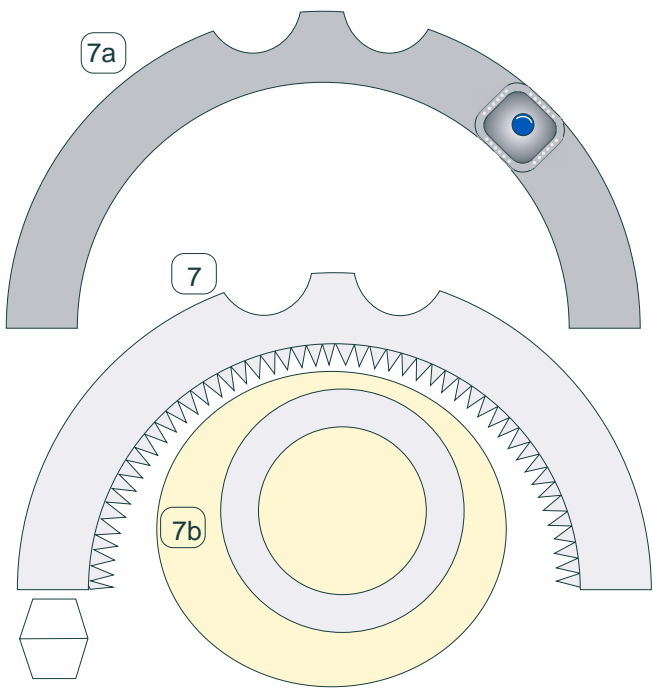
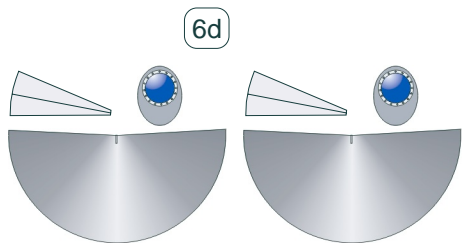
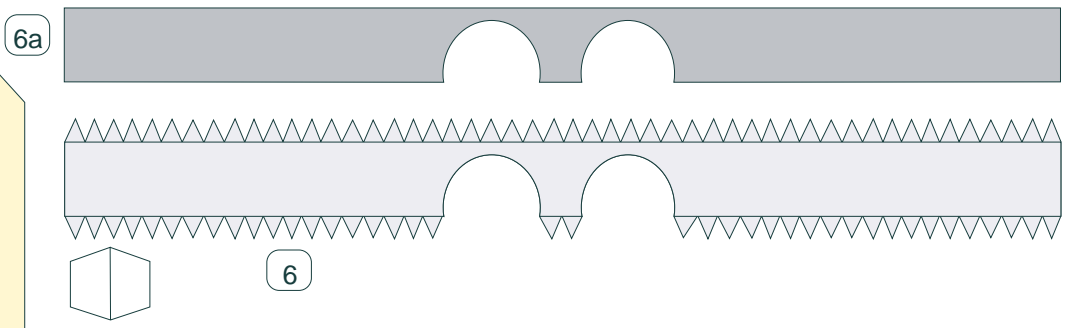
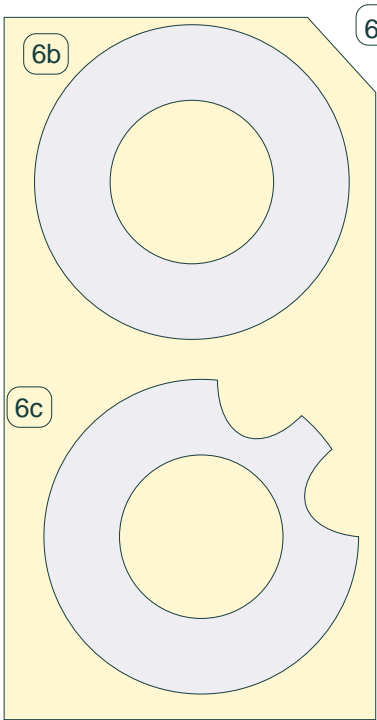
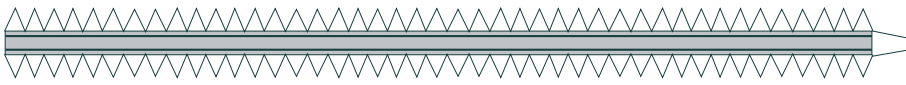
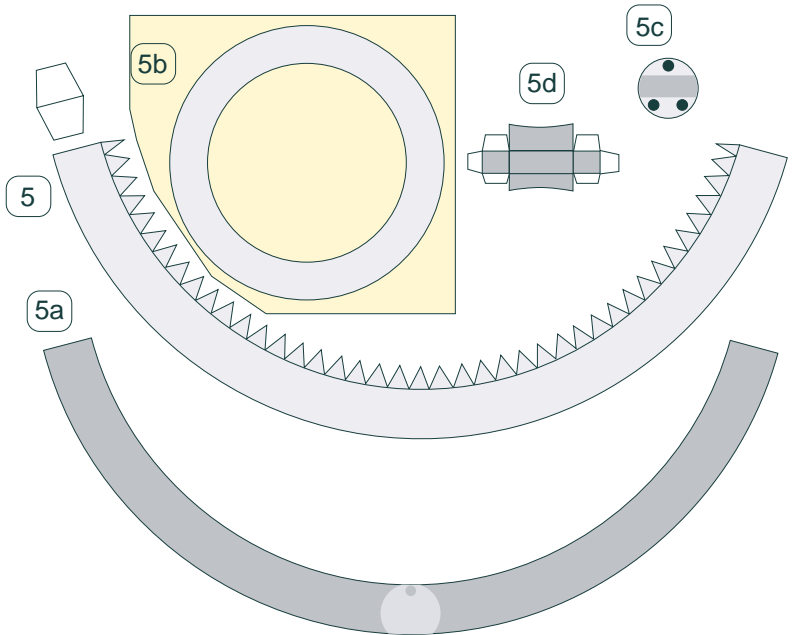
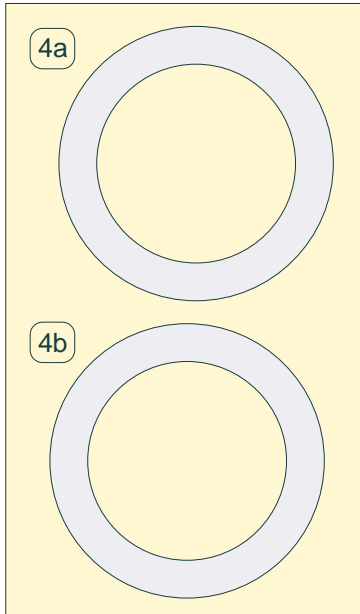

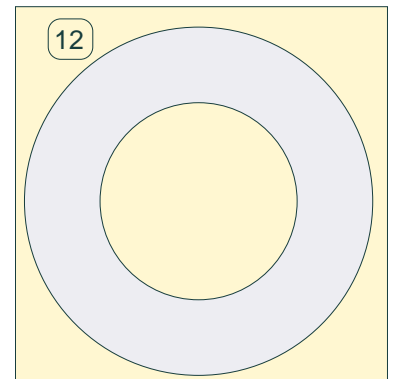
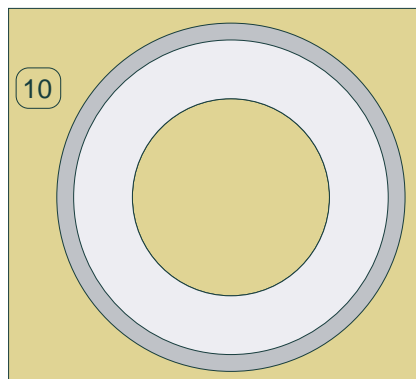
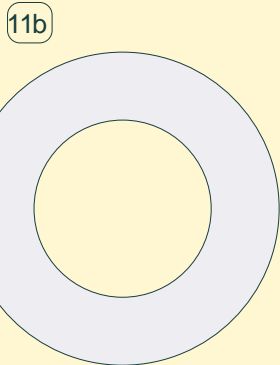
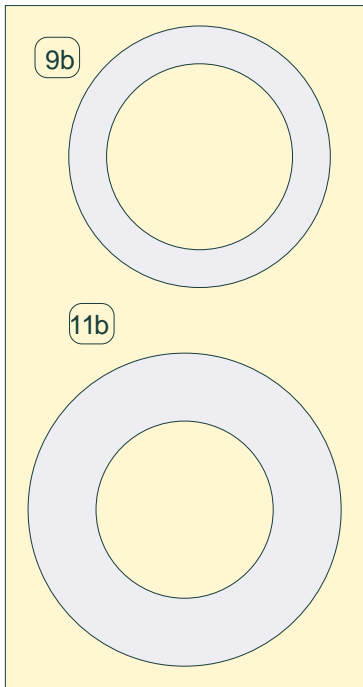
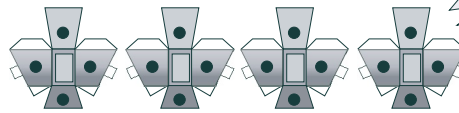
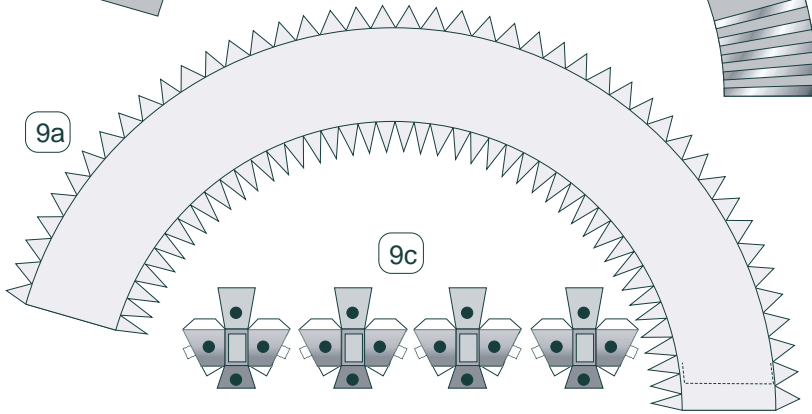
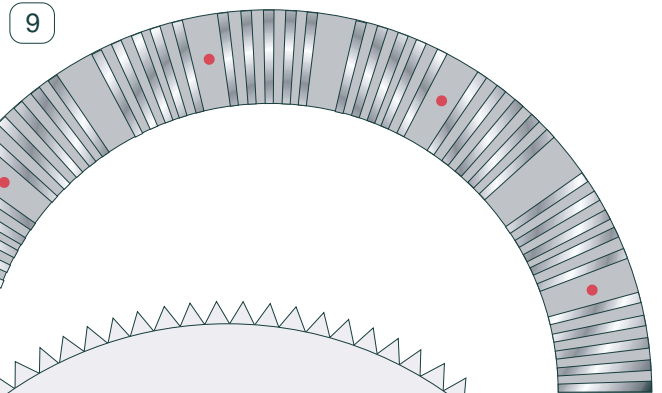
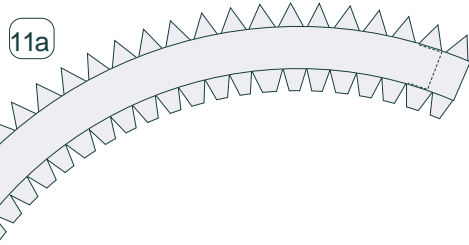
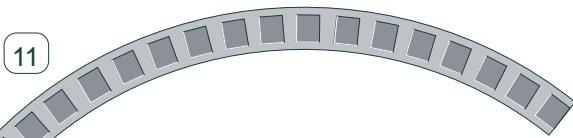
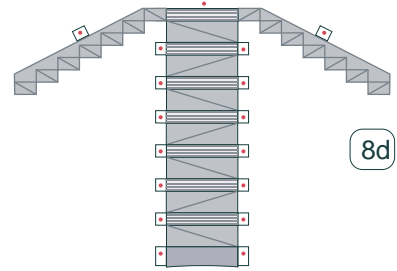
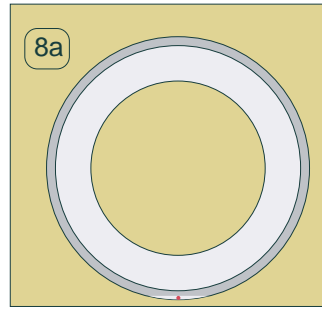
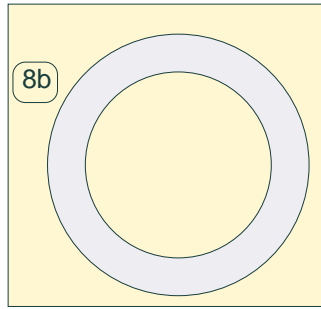
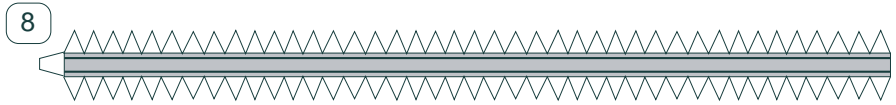

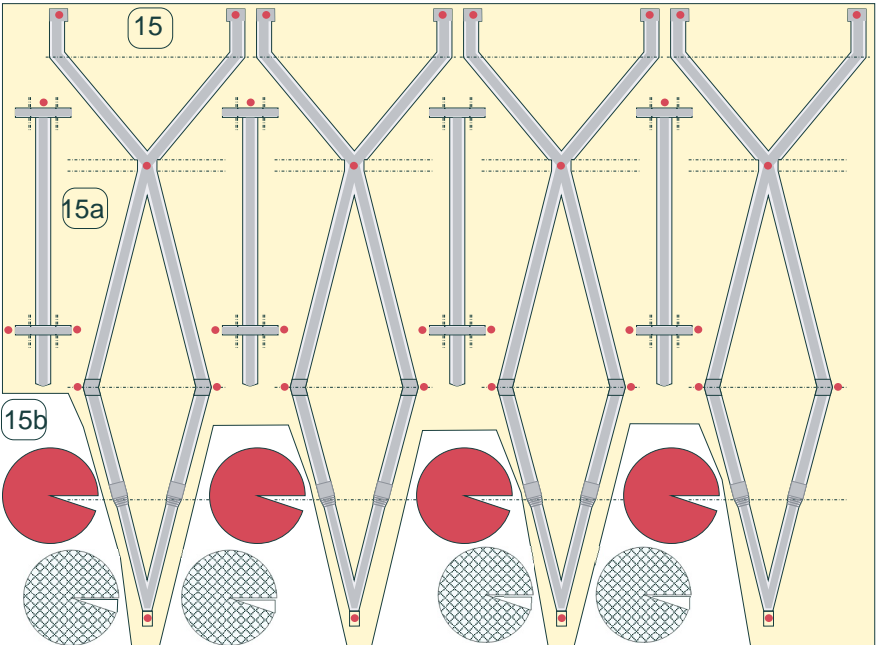
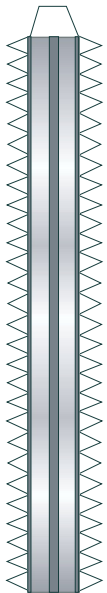
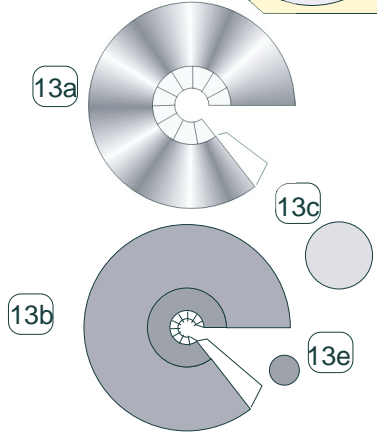
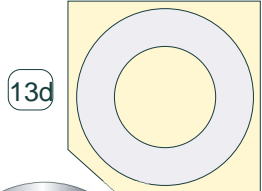
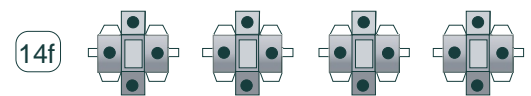
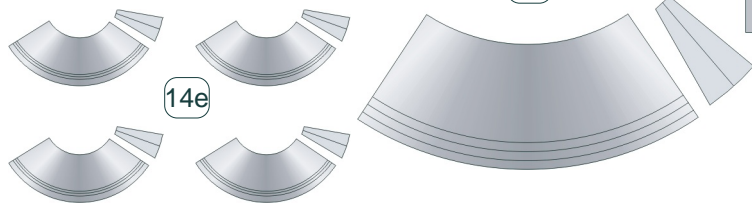
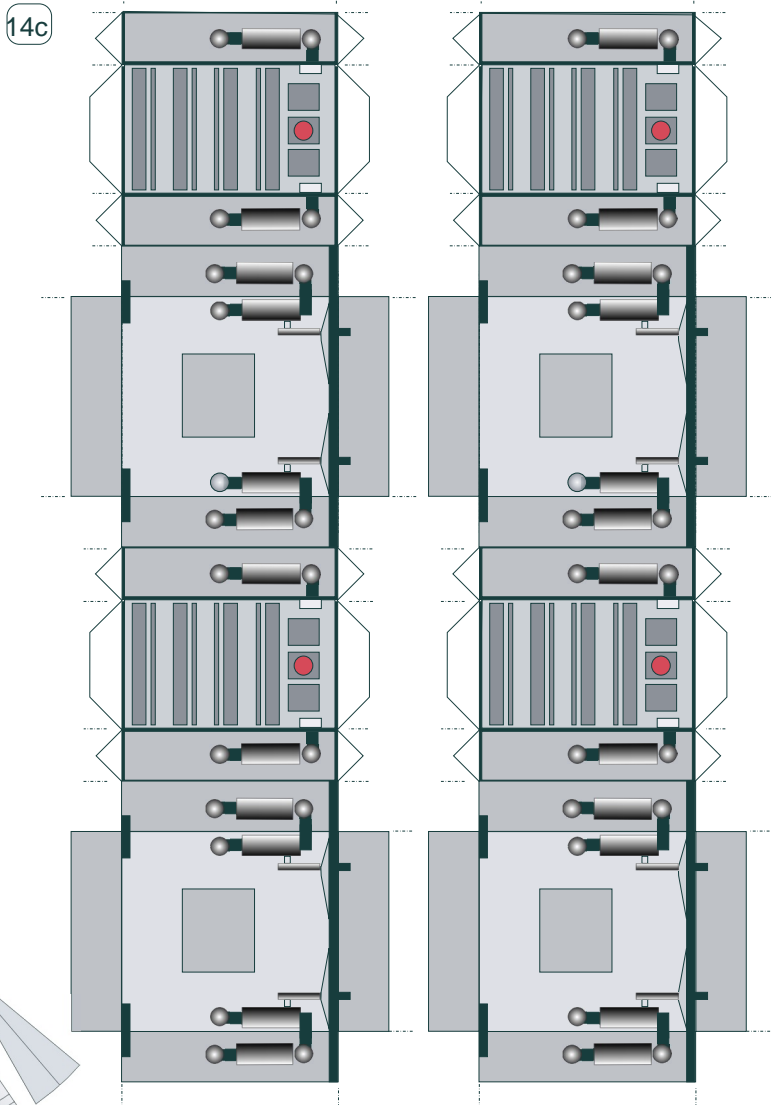
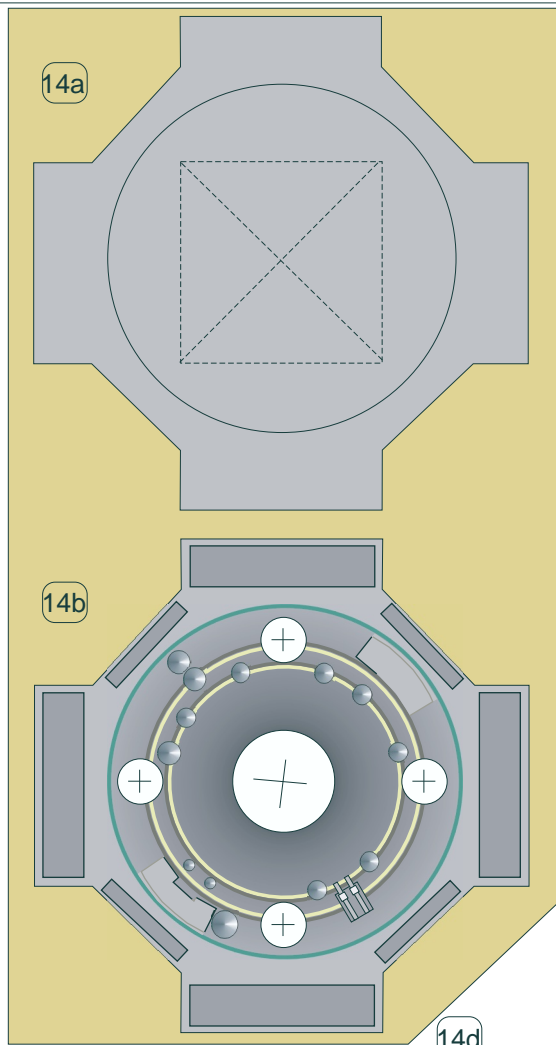

Assembling of the Command Module

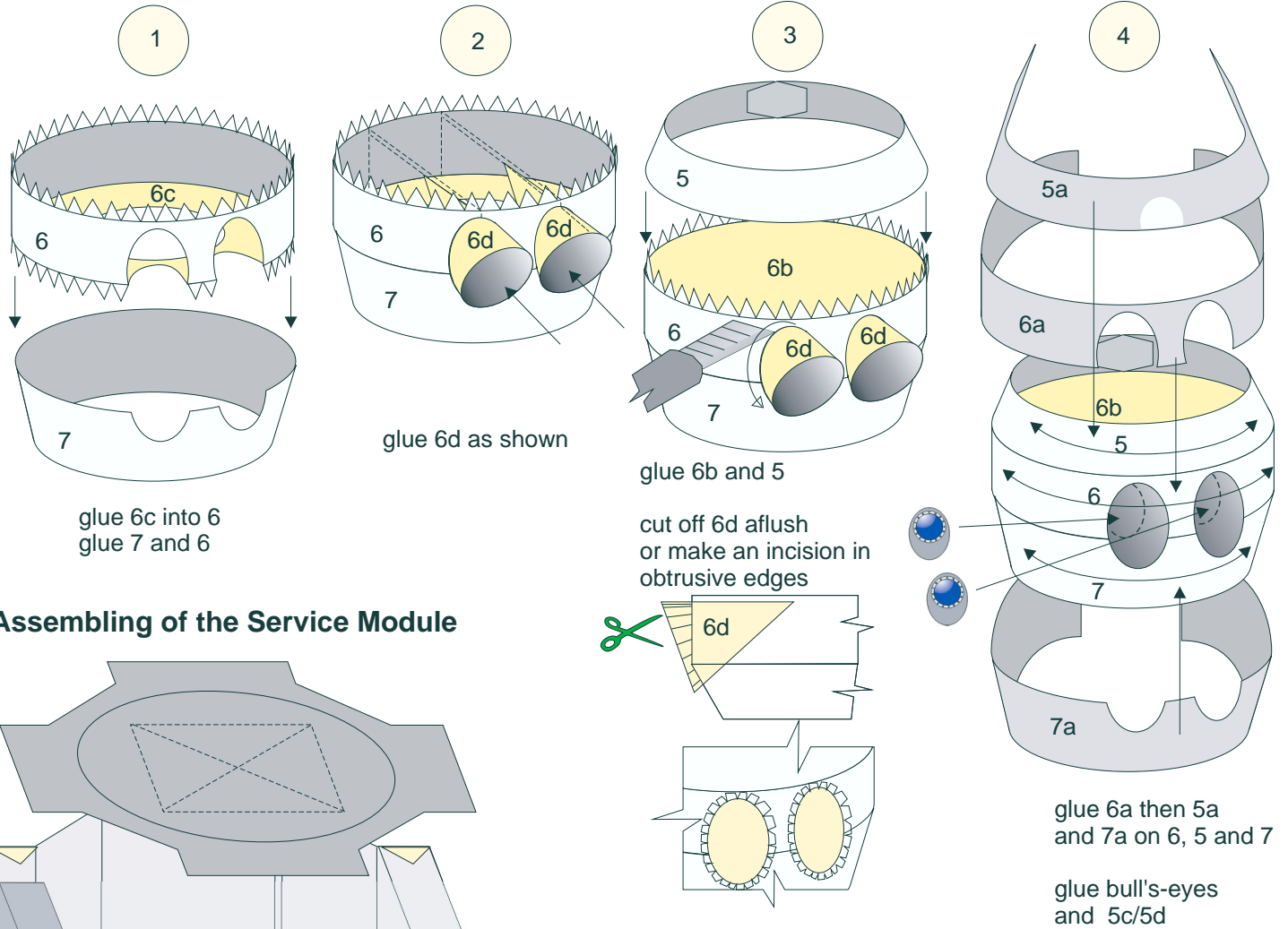

Assembling of the Service Module

