

Priroda

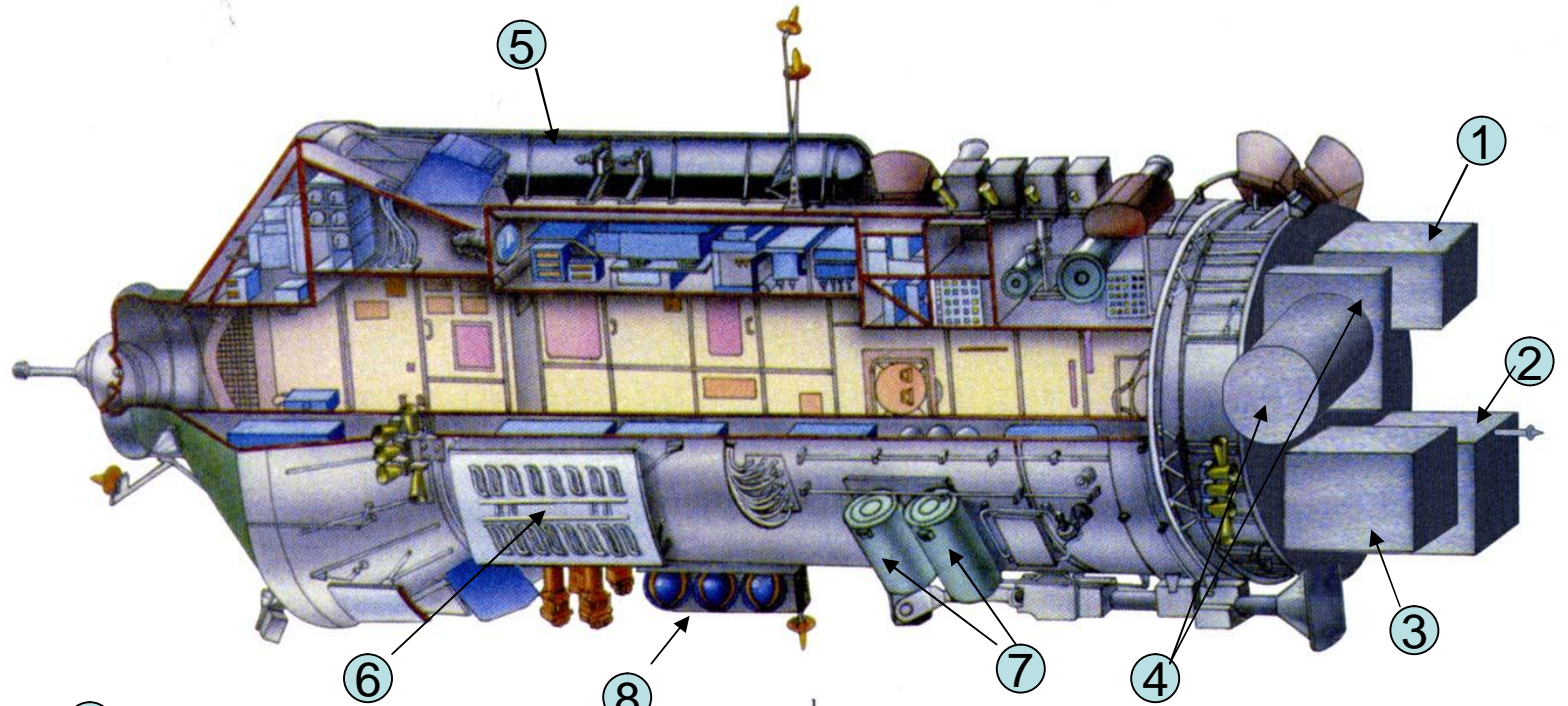

Spektr

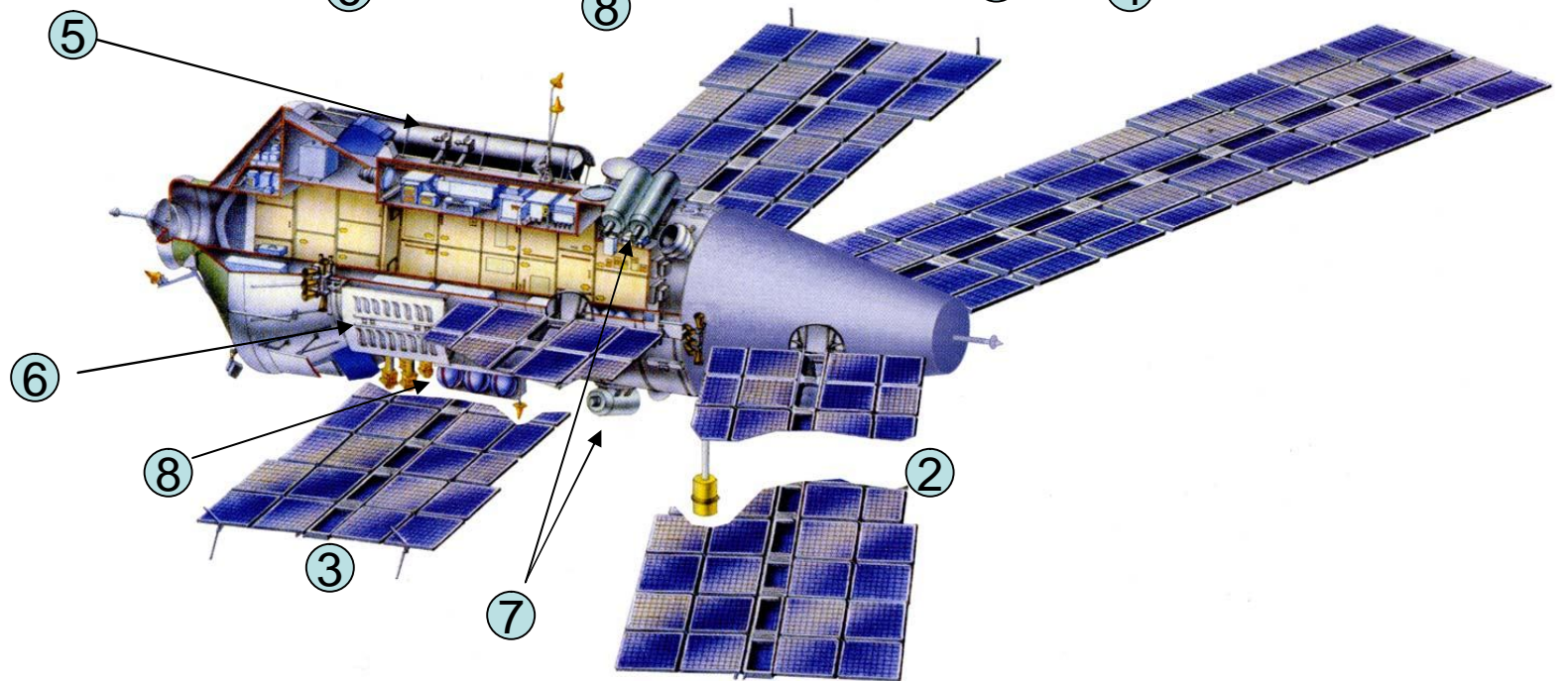

Priroda

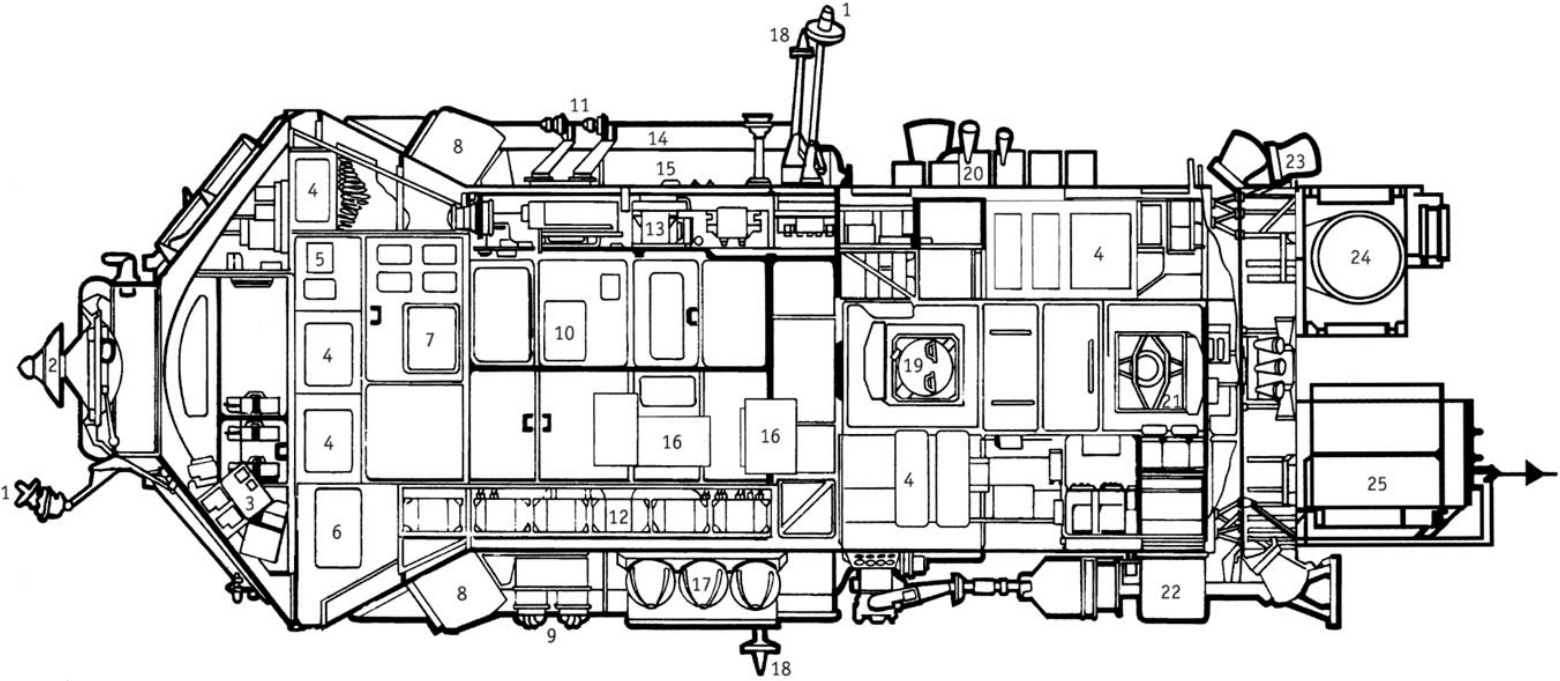

Spektr

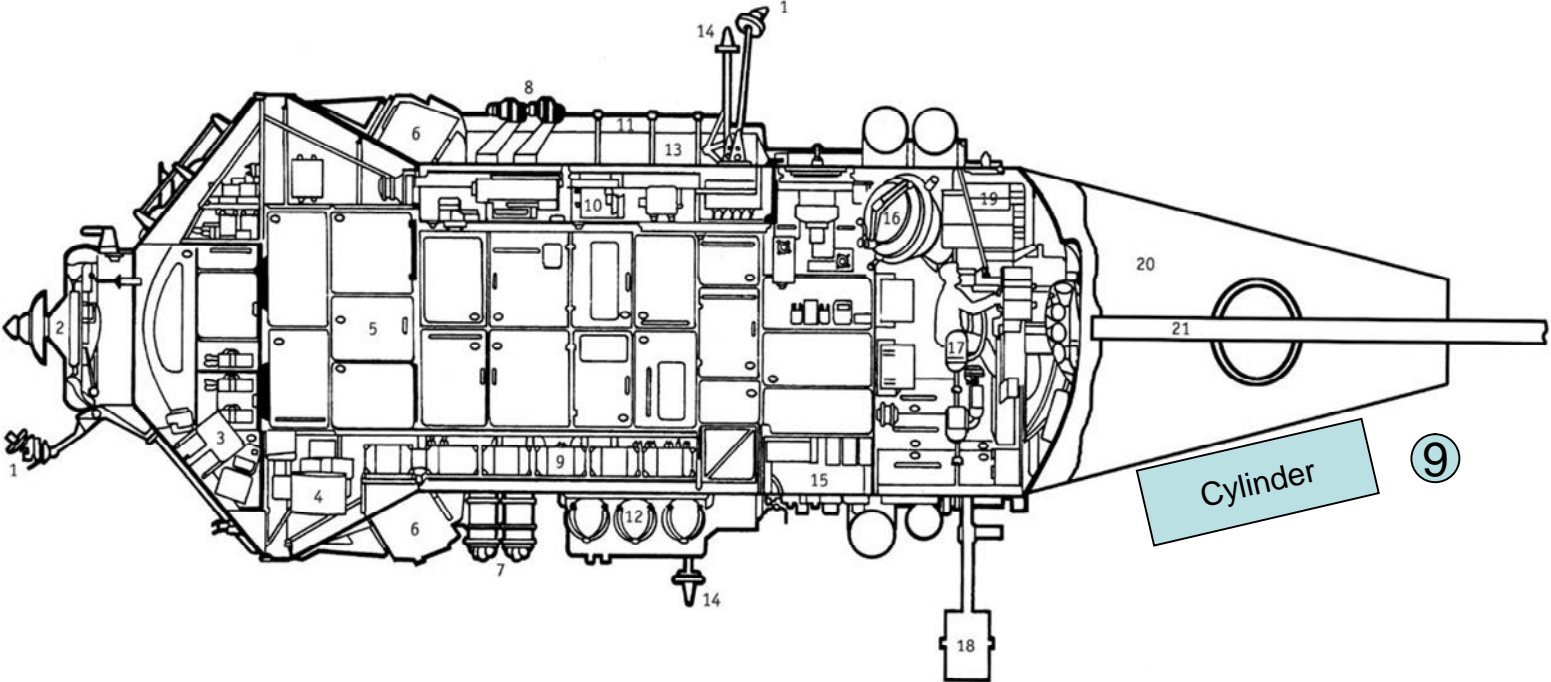

PRIRODA

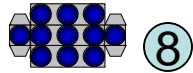

8

GLUE TO THICK CARD IF USED,
ATTACH TO KEEL OF MODULE
OVER GRAPHIC.



BODY CYLINDER

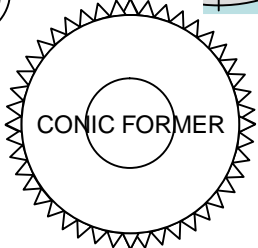
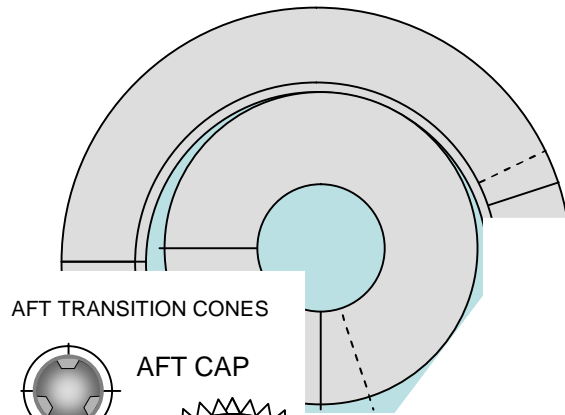
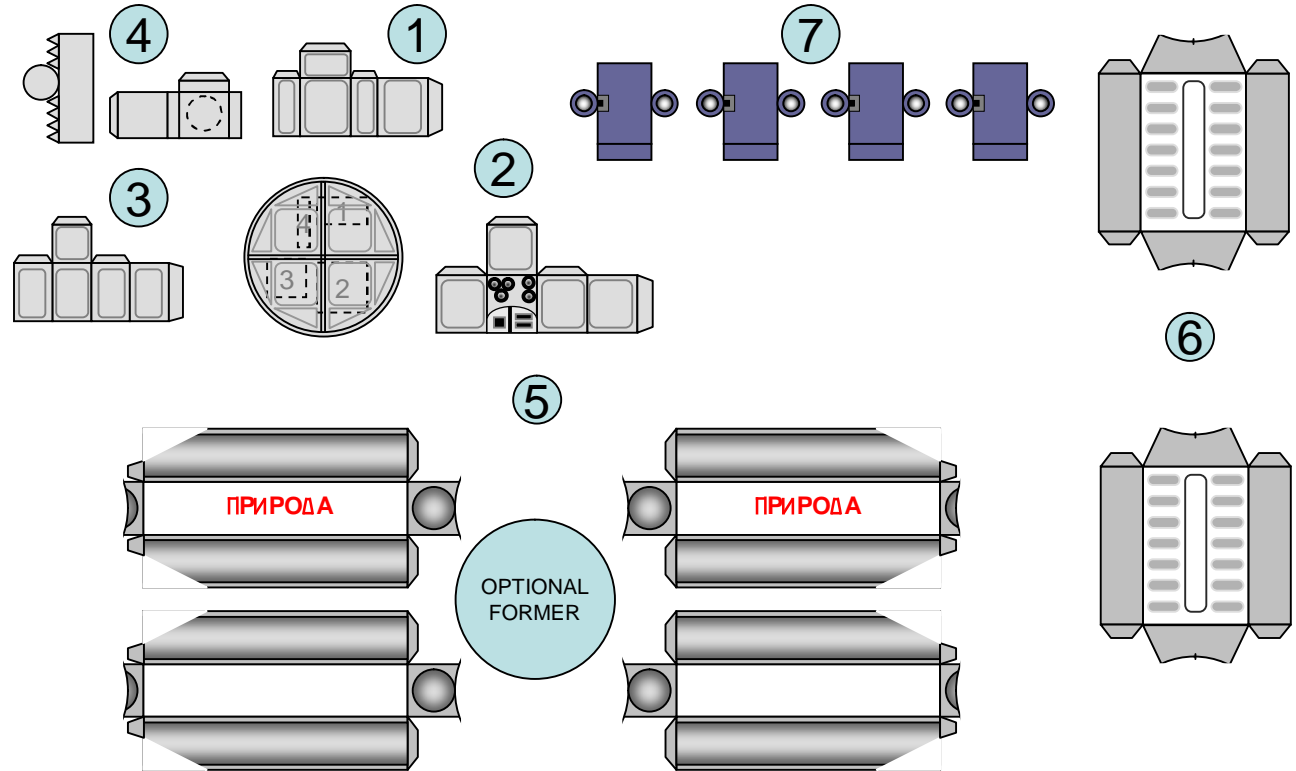
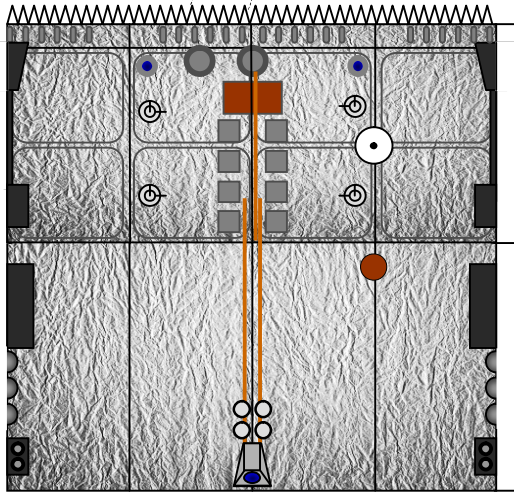

FOLD TABS IN
ALTERNATE DIRECTIONS
TO CONNECT TO CONES
(2) FORE AND AFT OF
THE FORMER

SPEKTR

Copyright 2010-John Jogerst. Not for commercial use. For private or educational use only.

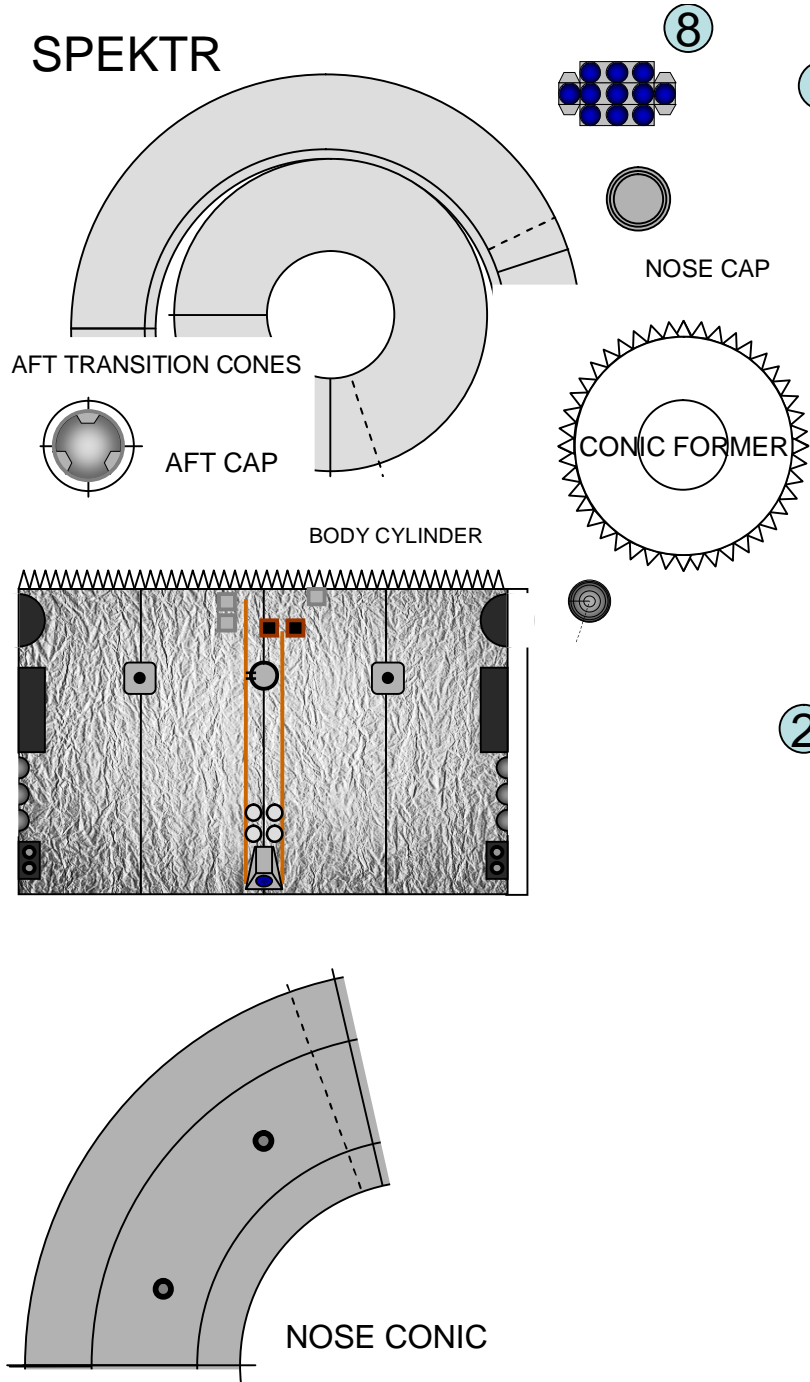

3

BODY SOLAR PANEL

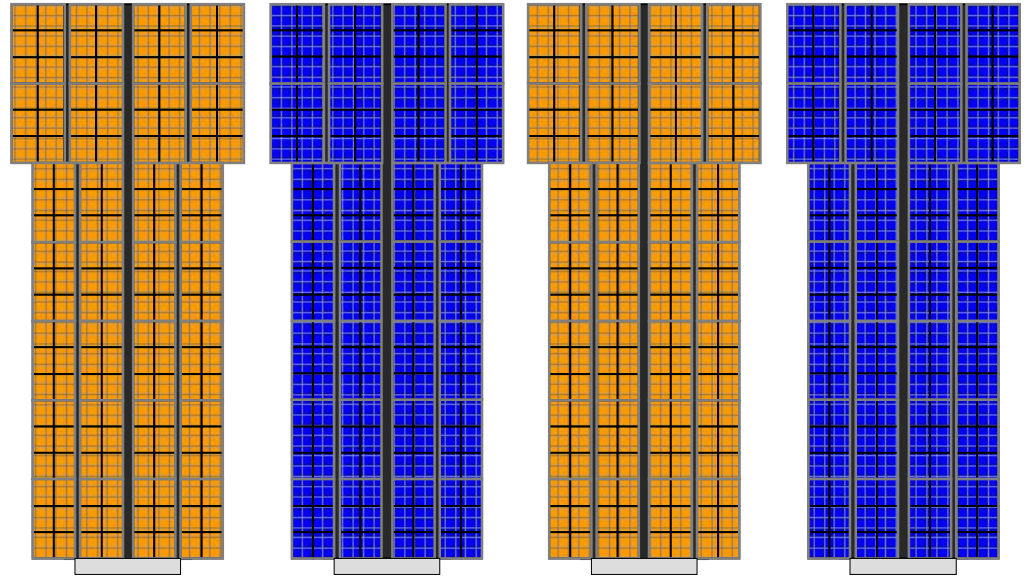

2

NOSE SOLAR PANEL

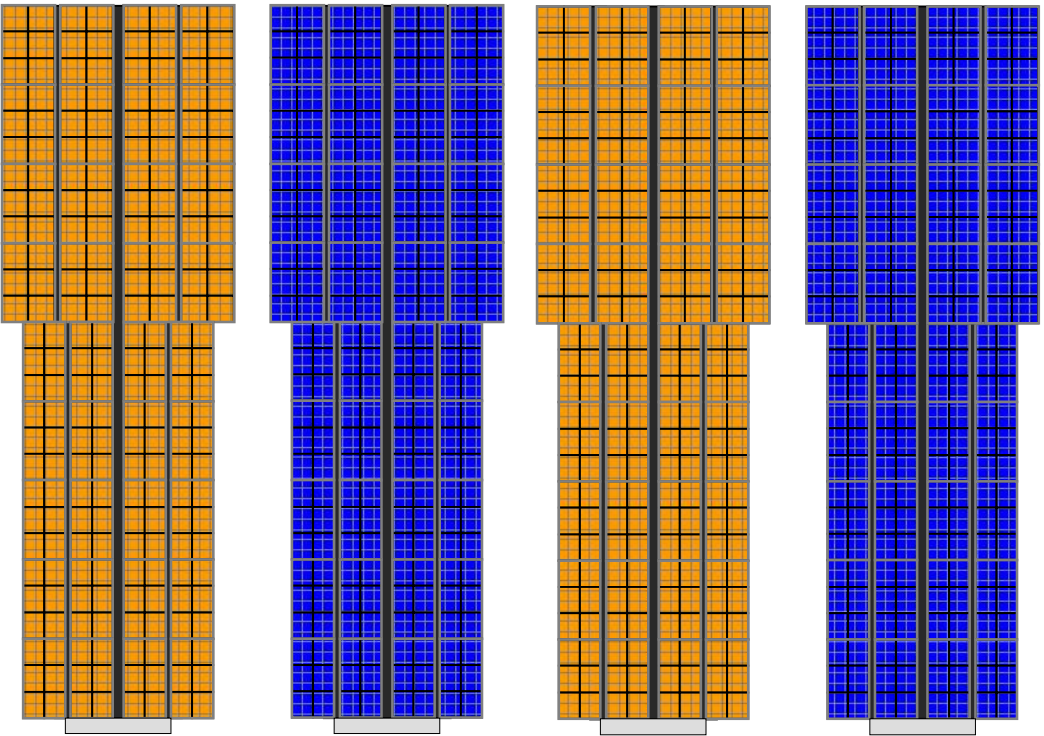

SPEKTR EQUIPMENT CABINETS

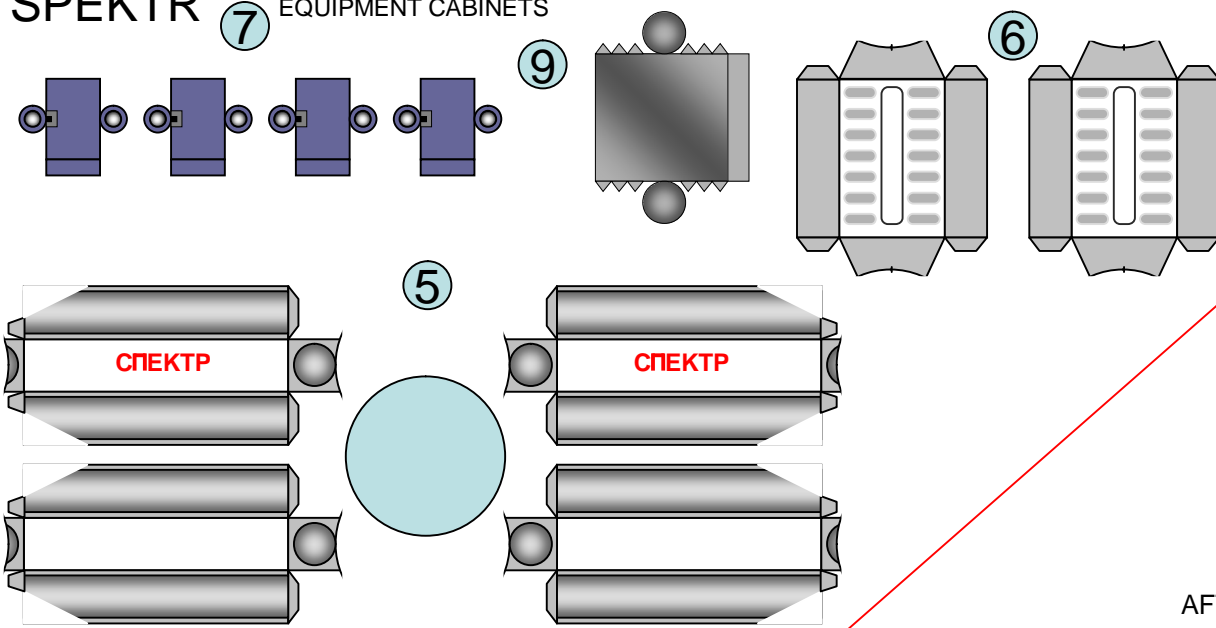

PROGRESS

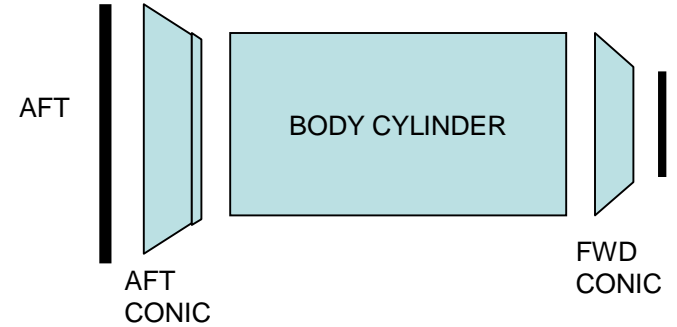

FWD CONIC

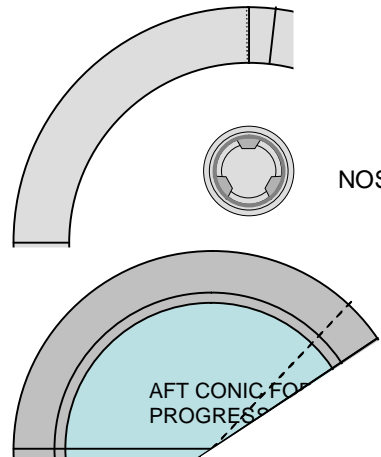

NOSE CAP

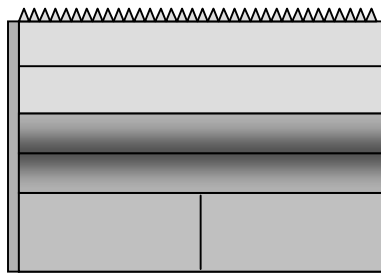

BODY CYLINDER

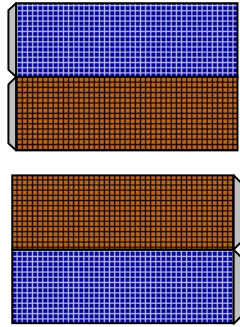

PROGRESS ARRAYS

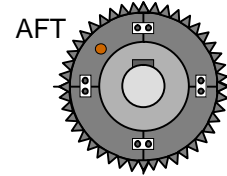

AFT