

Kvant-2

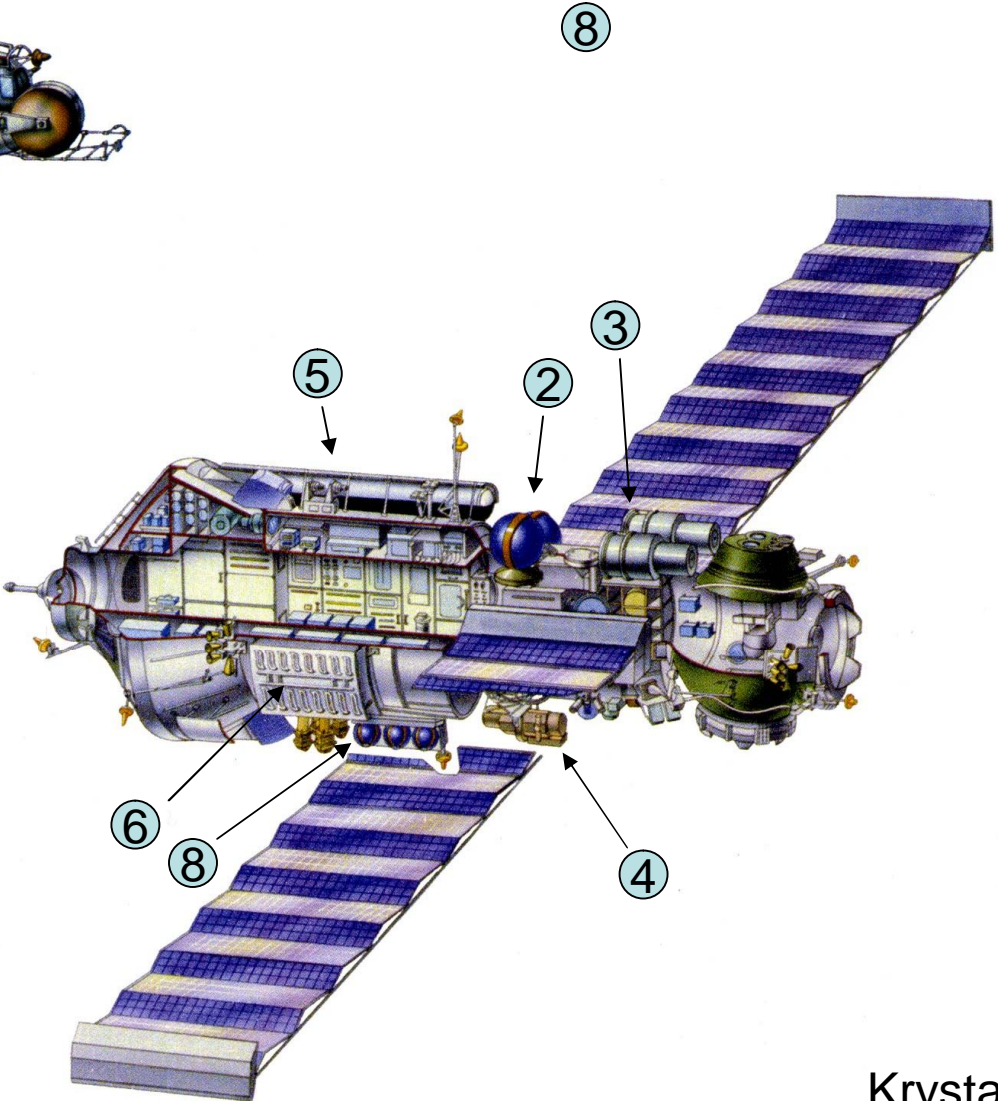

Krystal

Kvant-2

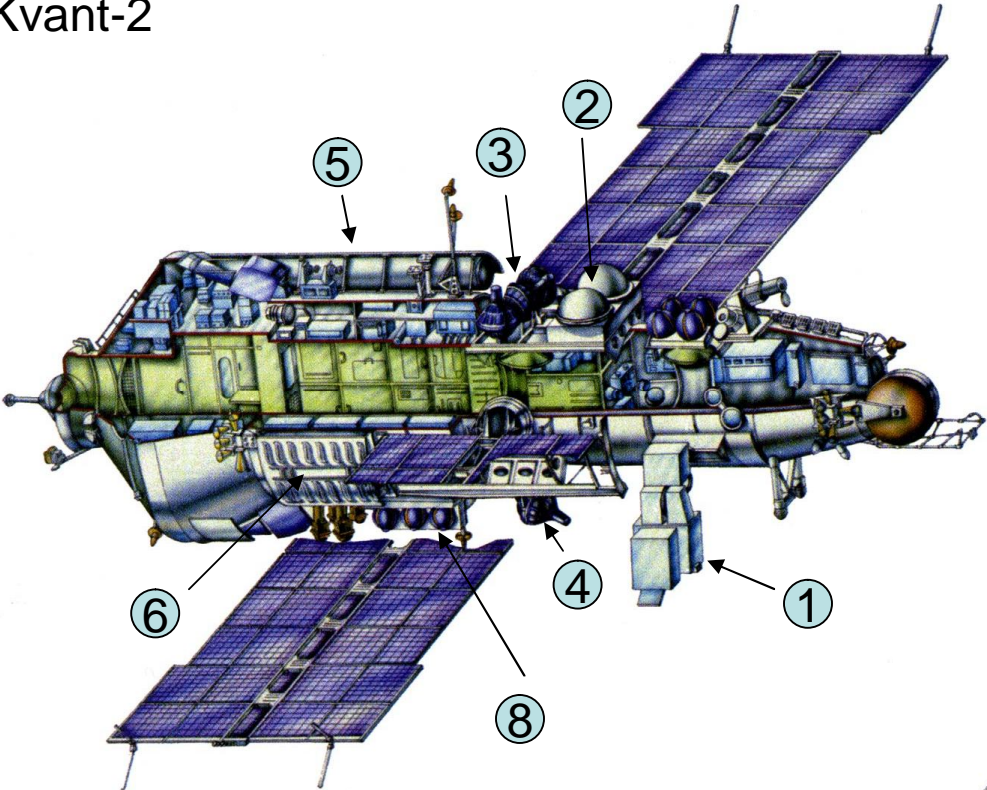
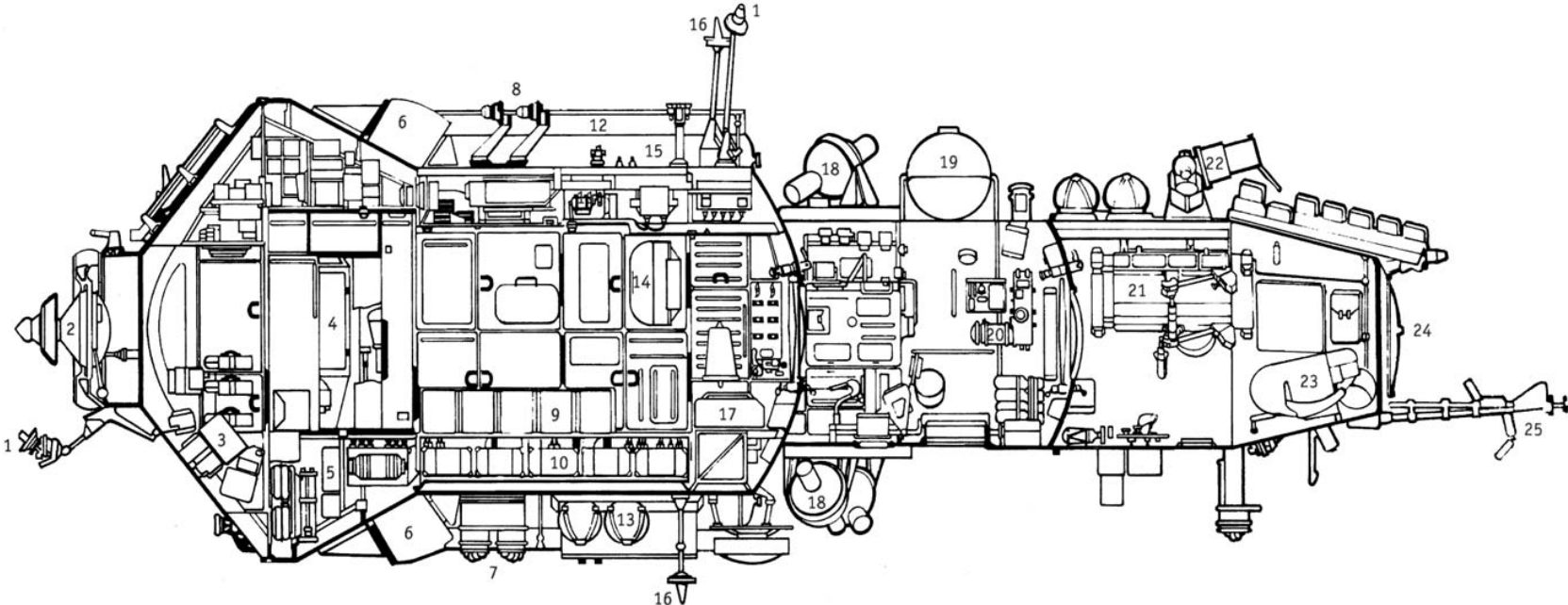

Krystal

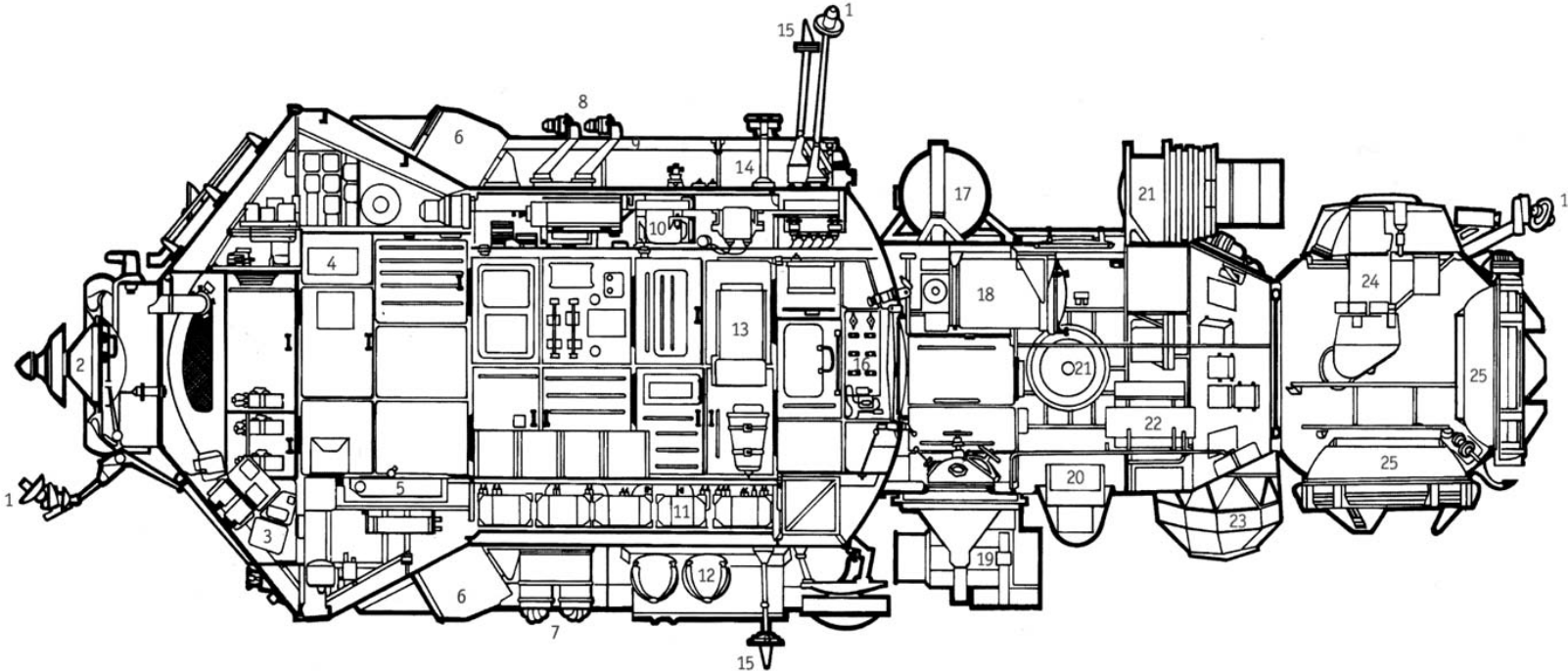

KVANT-2

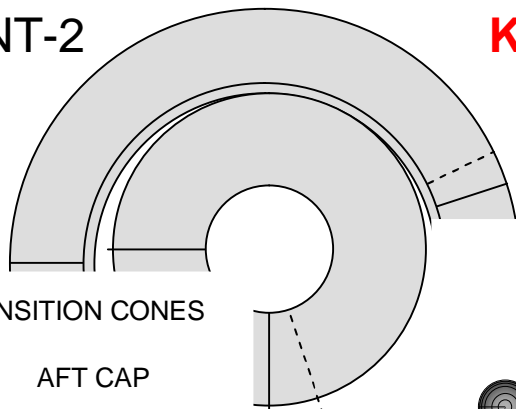

AFT TRANSITION CONES



AFT CAP

BODY CYLINDER

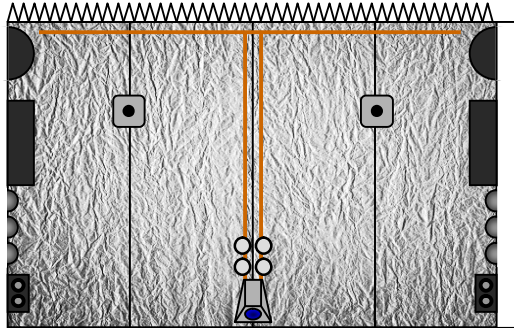

KBAHT-2



FWD CAP

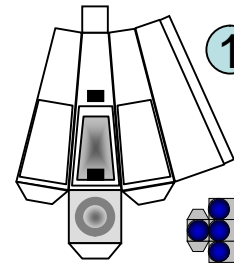
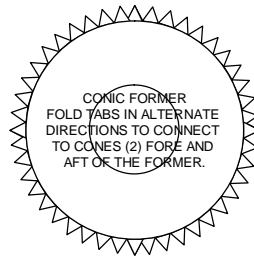

1

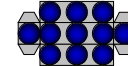

8

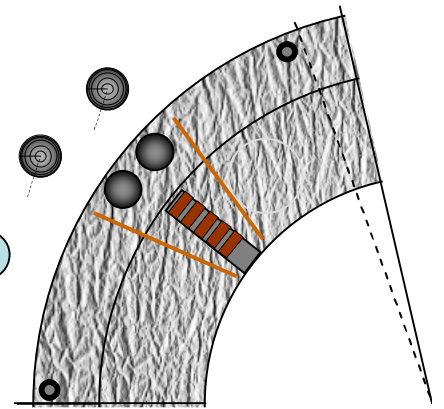

EQUIPMENT CABINETS



2

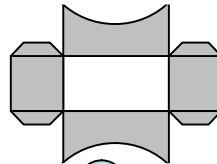

3

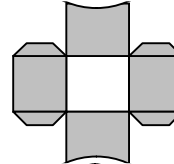

4

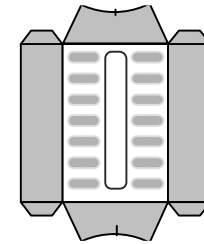

6

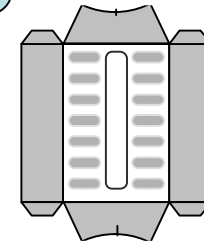

SOLAR PANEL

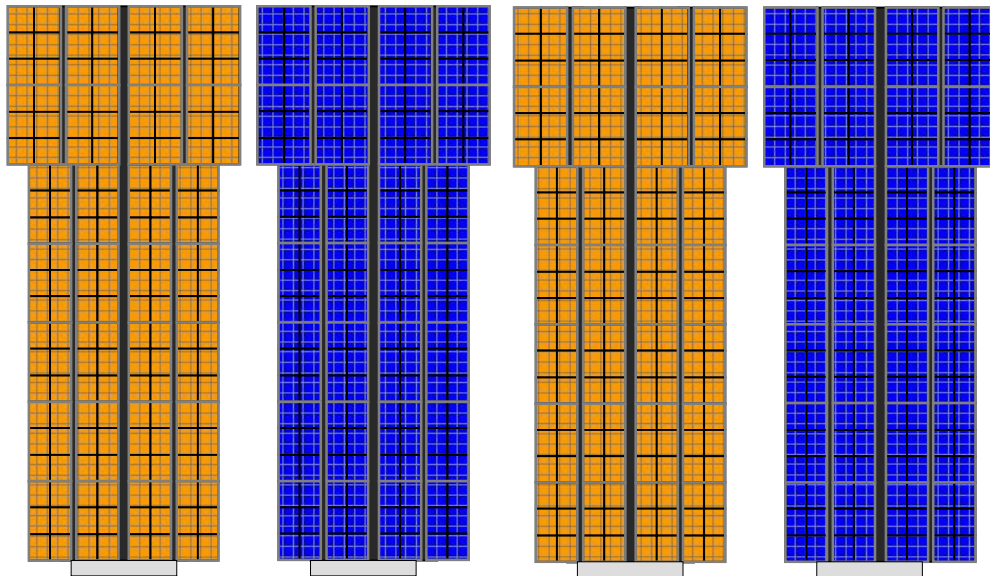

OPTIONAL FORMER

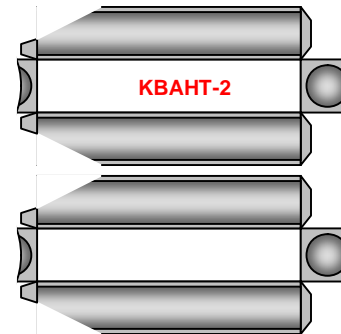

5

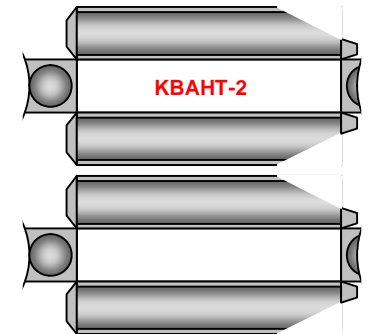

KRYSTAL

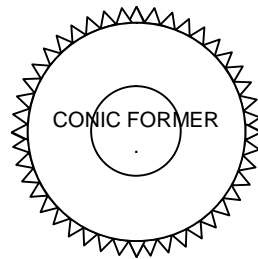
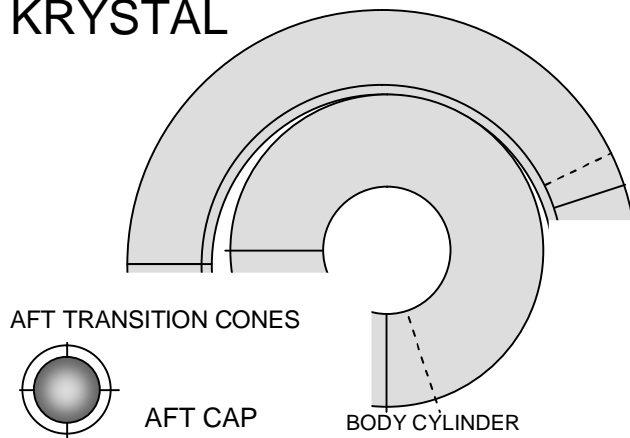

FOLD TABS IN ALTERNATE DIRECTIONS TO CONNECT TO CONES (2) FORE AND AFT OF THE FORMER

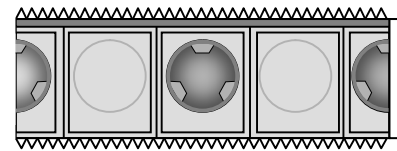

AIRLOCK SECTION

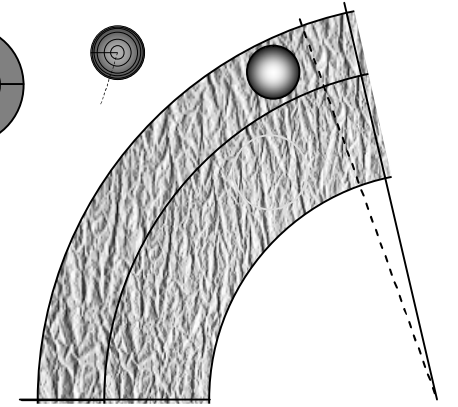
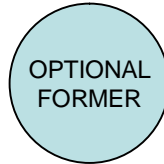
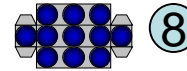

NOSE CONE

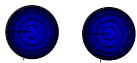
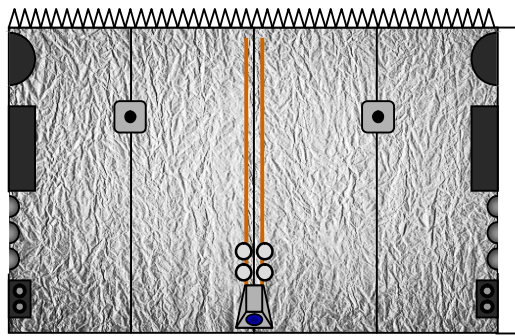

EQUIPMENT CABINETS

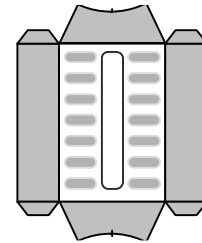
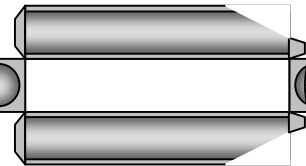
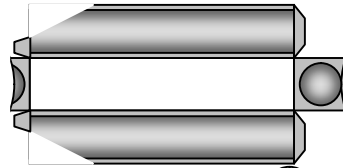
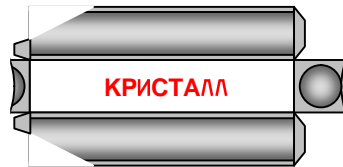
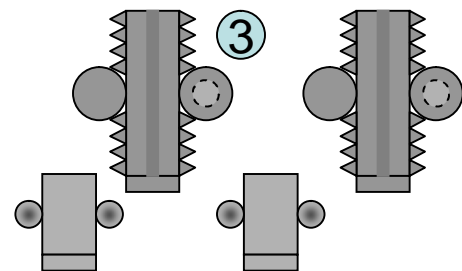
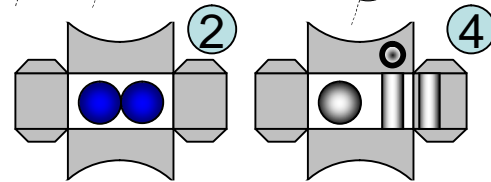

6

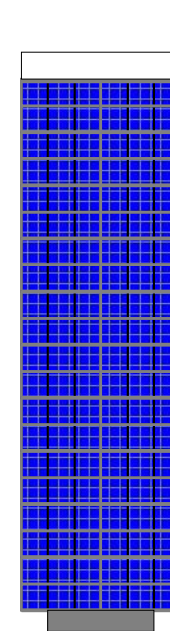
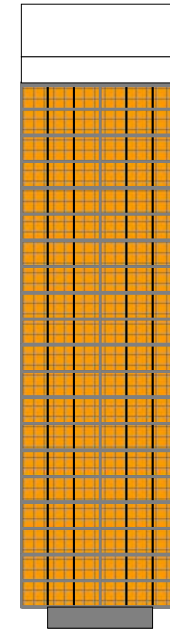
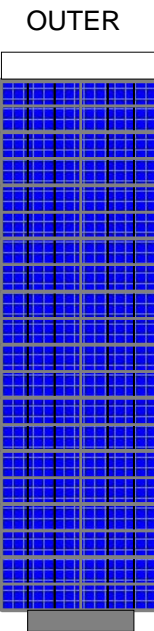
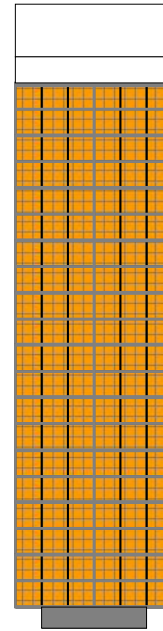
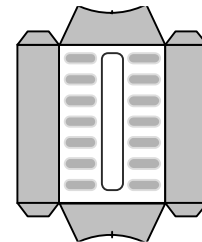

OUTER

INNER

Glue up

OUTER

INNER

Then fold if desired

INNER

OUTER