

JUNO
1:24 scale

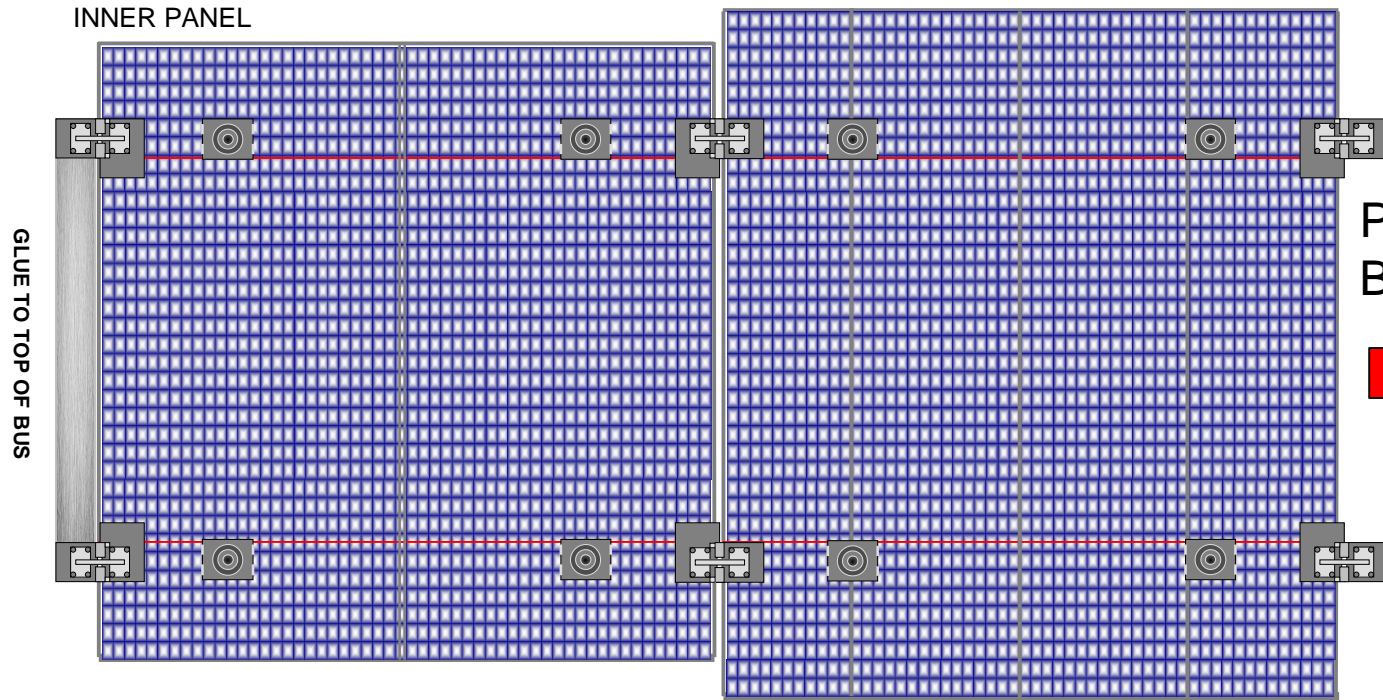

**PVA Wing with MAG
BOOM Top side**

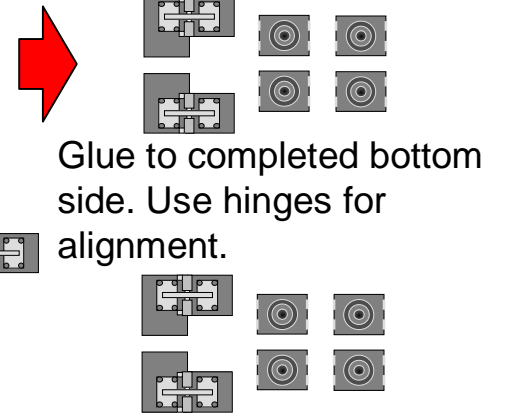

2011: John Jogerst. Not for commercial use. For personal or educational use only.

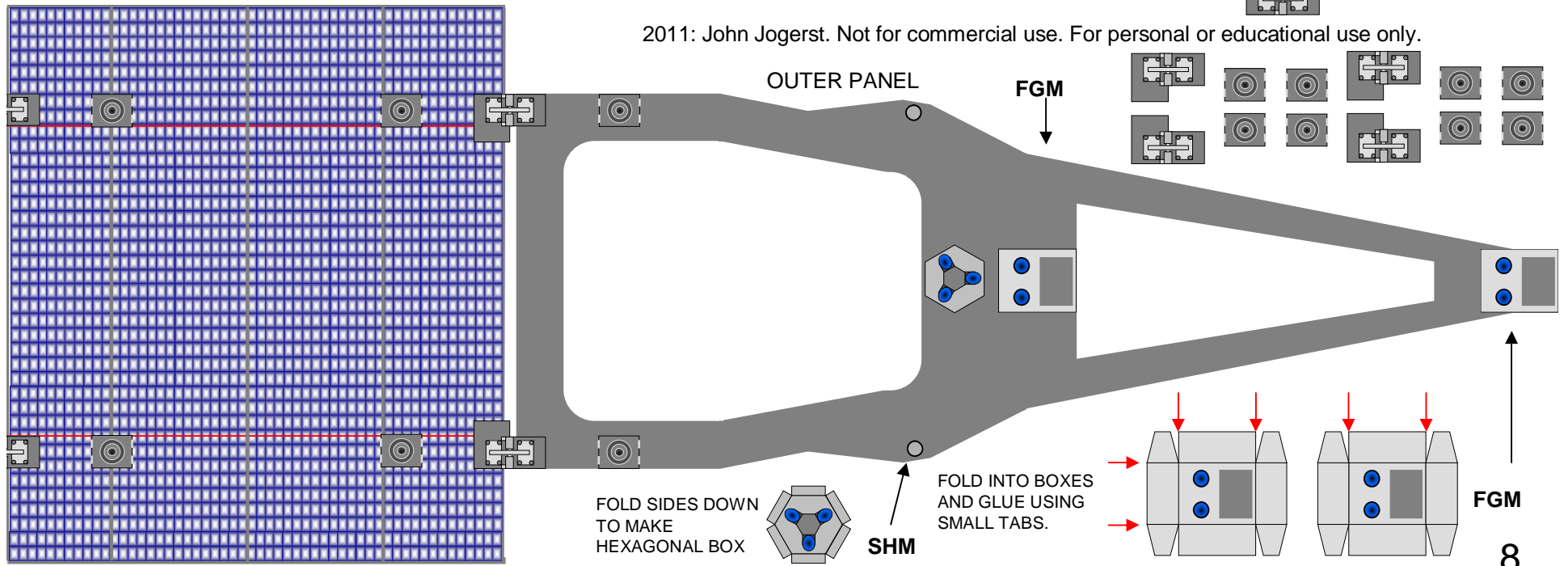

INNER PANEL

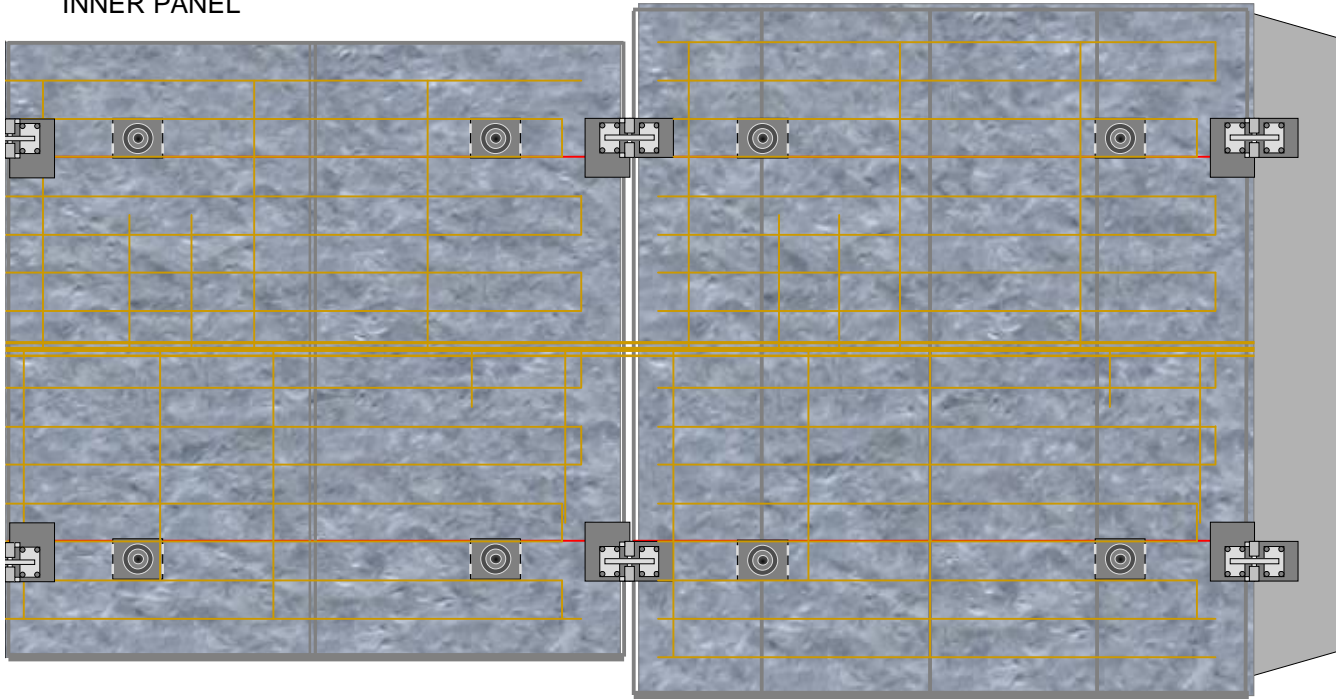

JUNO
1:24 scale

 A set of icons representing the components used in the model: two types of hinges and two types of circular connectors.

PVA Wing with MAG
BOOM Bottom side

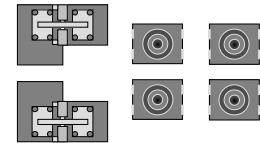

Use tab to glue inner and
outer sections together.
Use hinges for alignment.

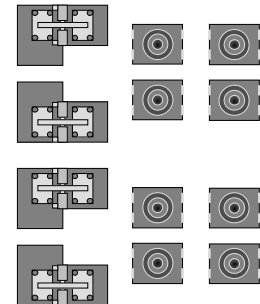

OUTER PANEL

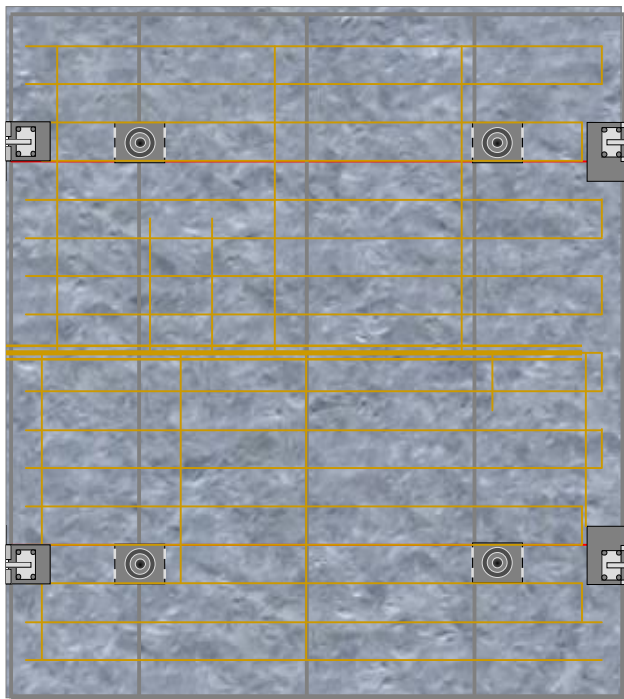

MAG Boom BEAMS

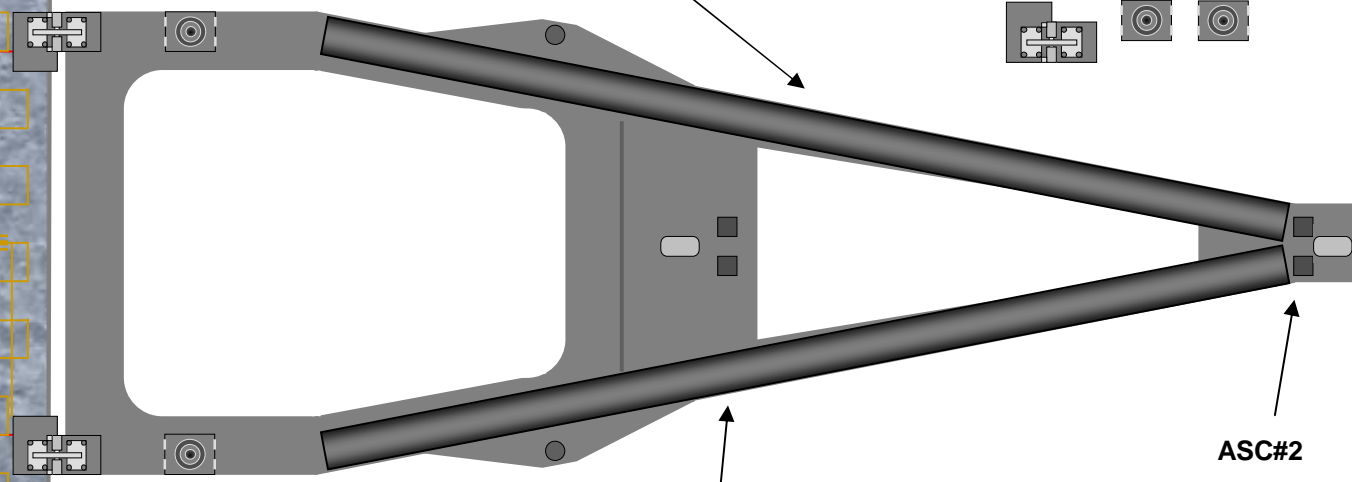

ASC#1

ASC#2

2011: John Jogerst. Not for
commercial use. For personal or
educational use only.

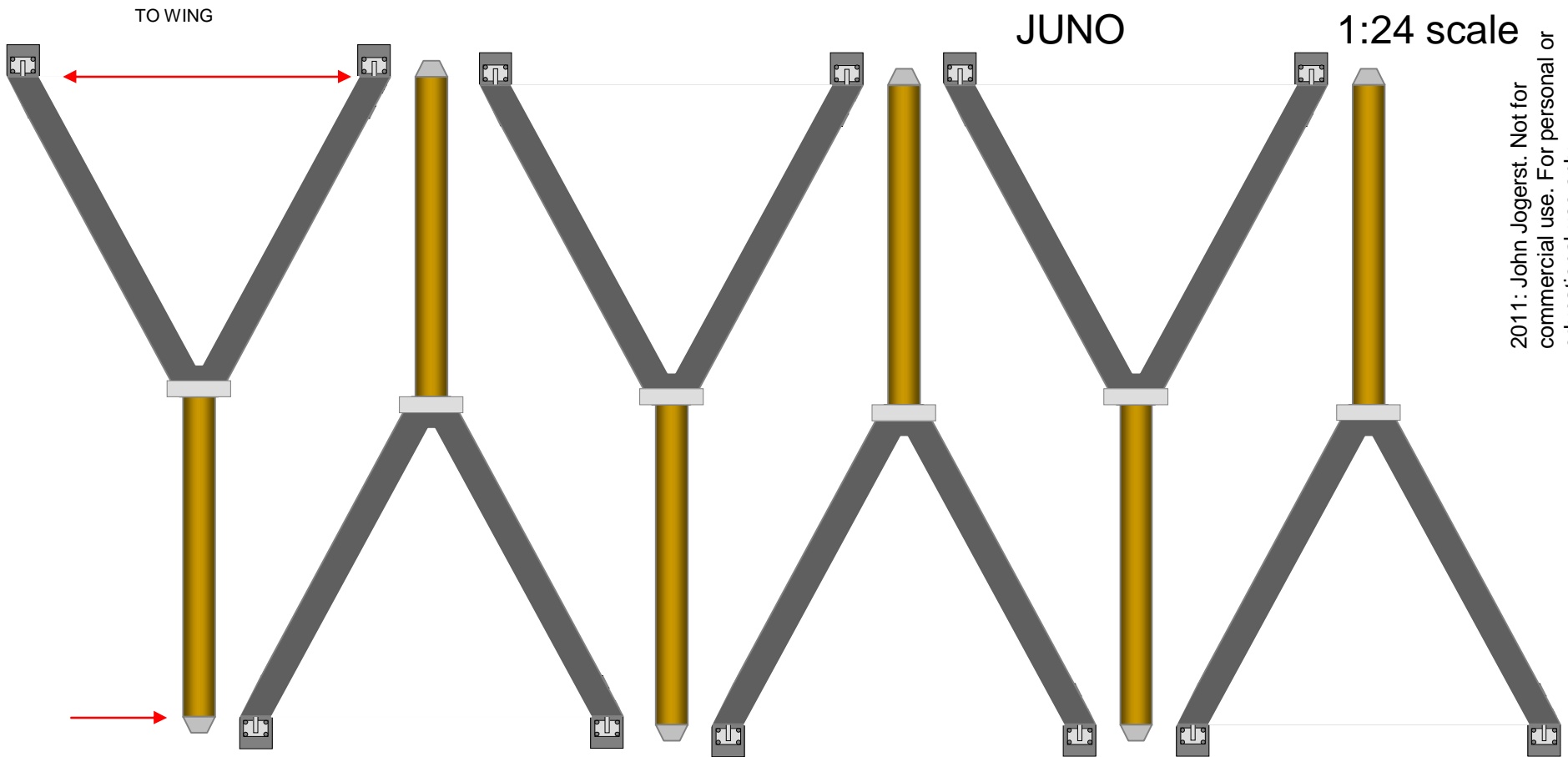

2011: John Jogerst. Not for commercial use. For personal or educational use only.

Wing Support Strut3: Laminate to thick card and glue two tabs to bottom of first wing hinge, single tab to face of bus.

11

MagBoom BEAMS

FOLD INTO SQUARE BEAMS AND GLUE TO THE BOTTOM OF THE MAG BOOM

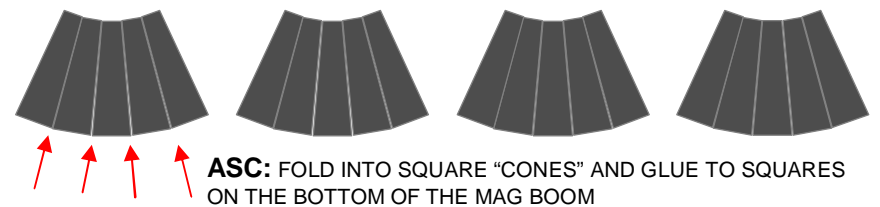

ASC: FOLD INTO SQUARE "CONES" AND GLUE TO SQUARES ON THE BOTTOM OF THE MAG BOOM