

Energia

scale 1:96

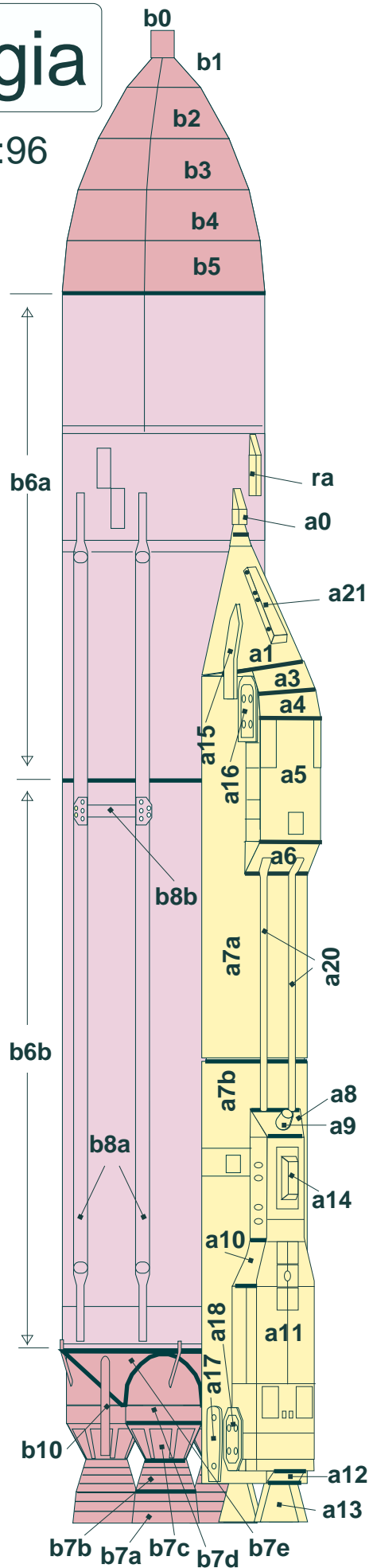
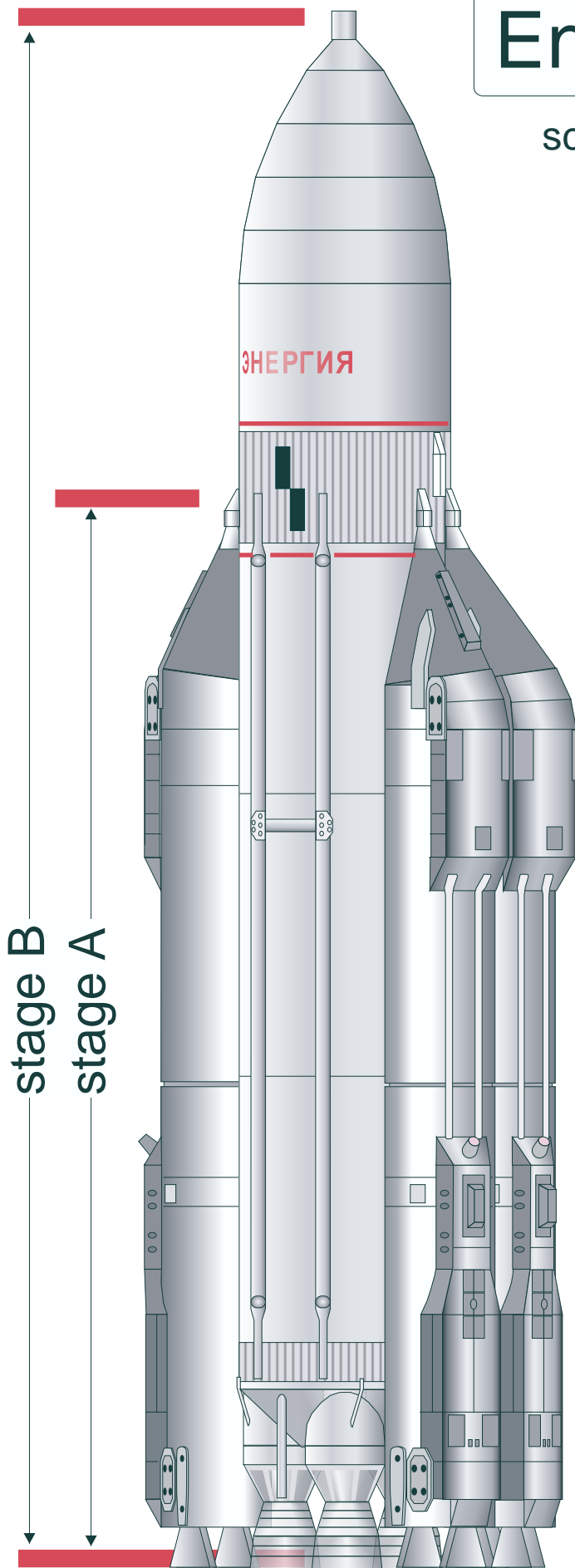

10 cm

10 cm

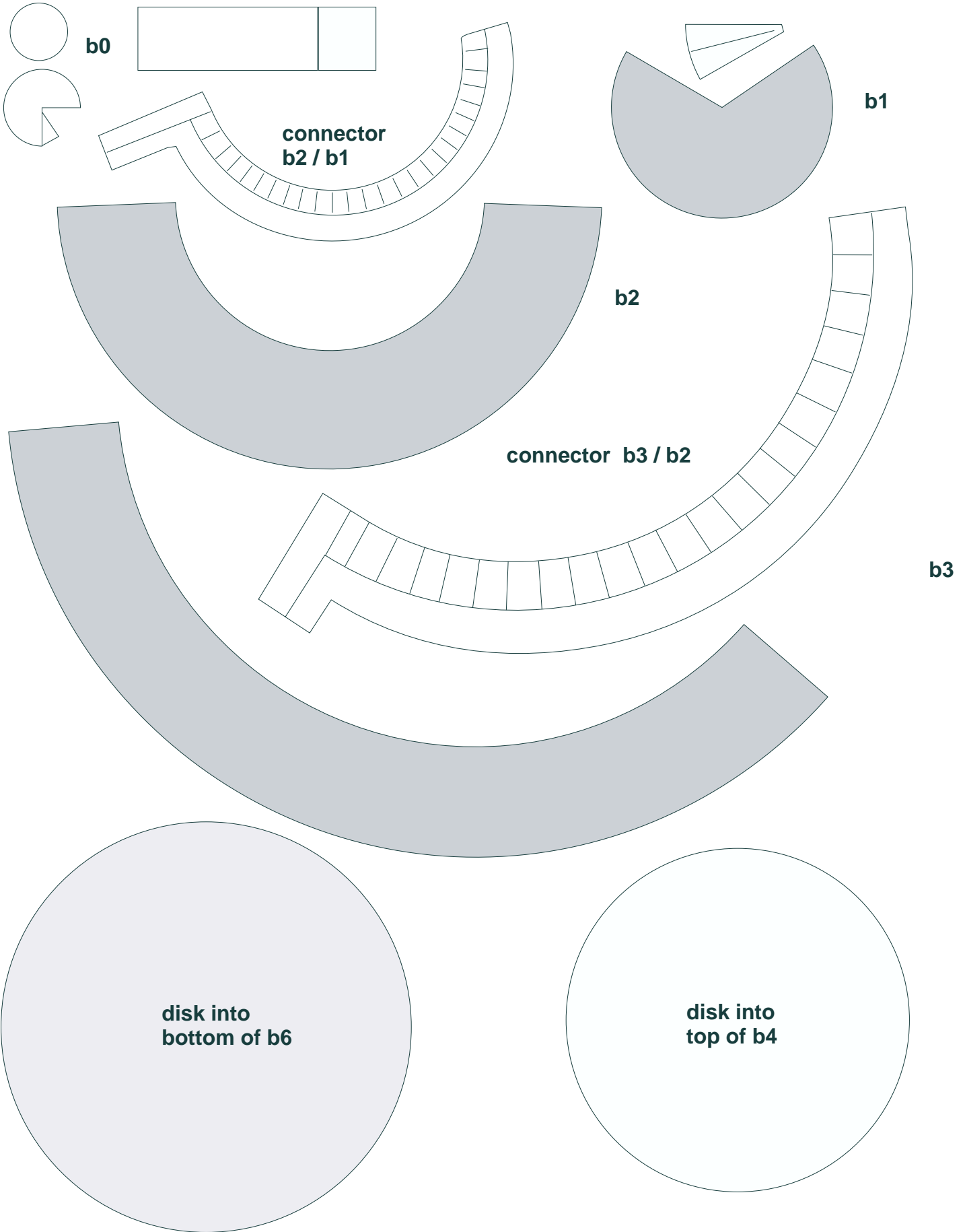

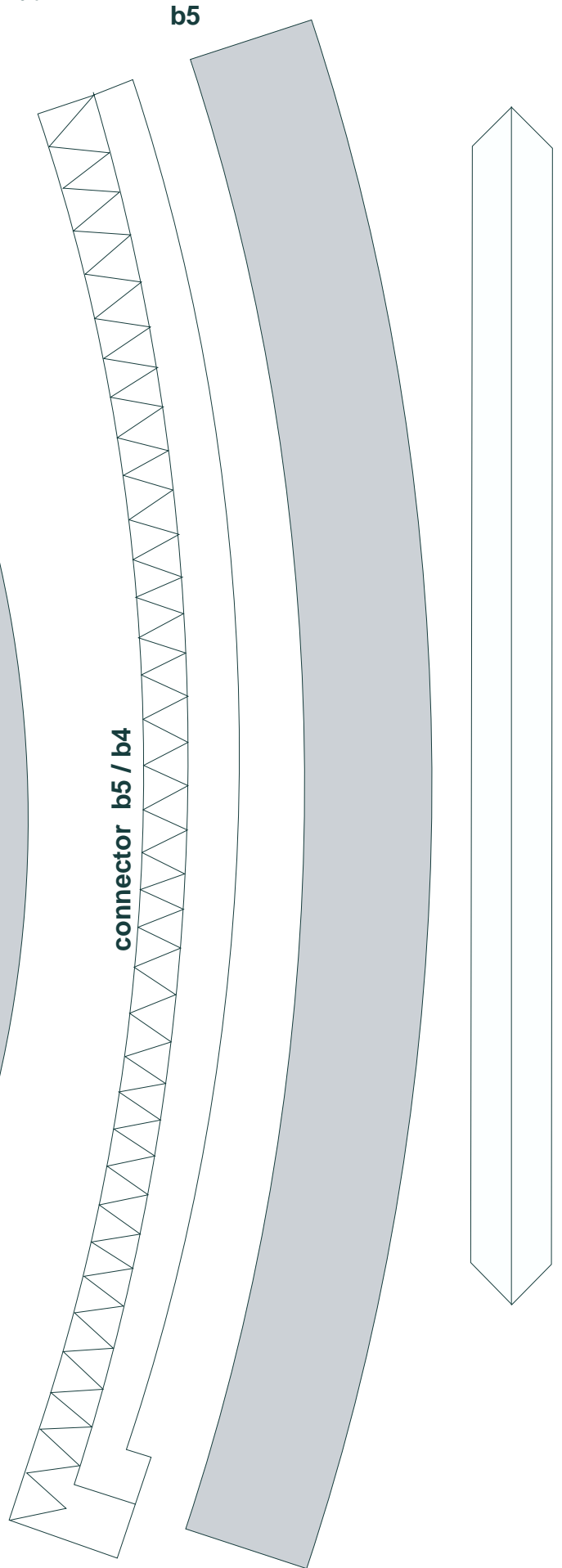
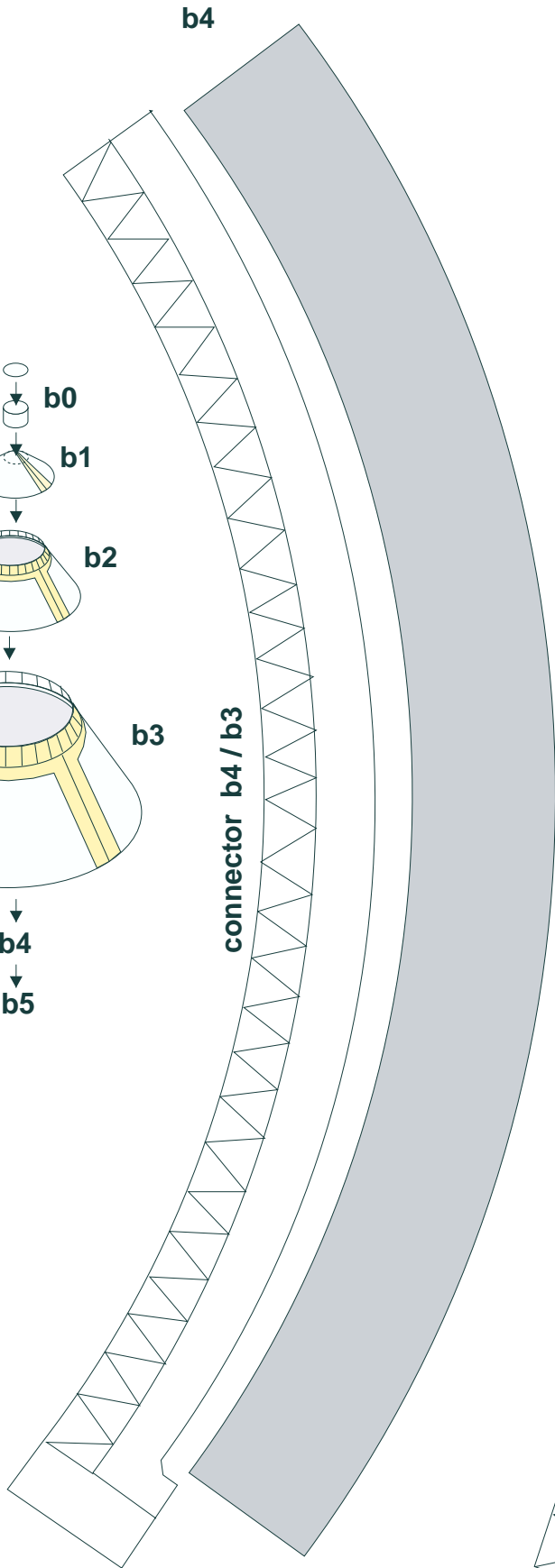
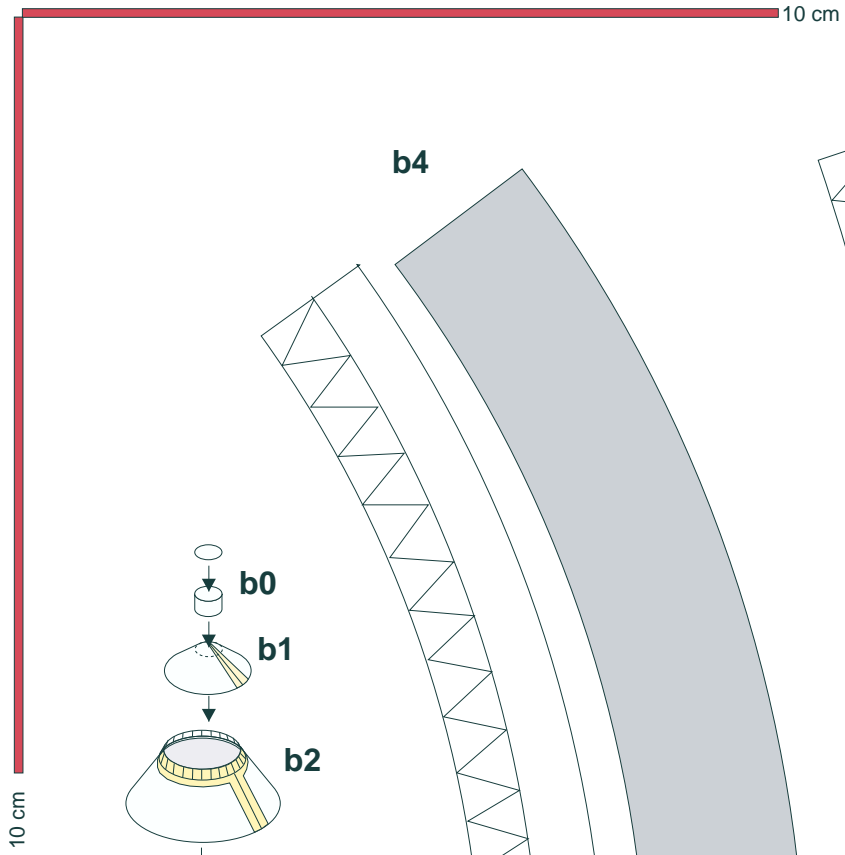

ЭНЕРГИЯ

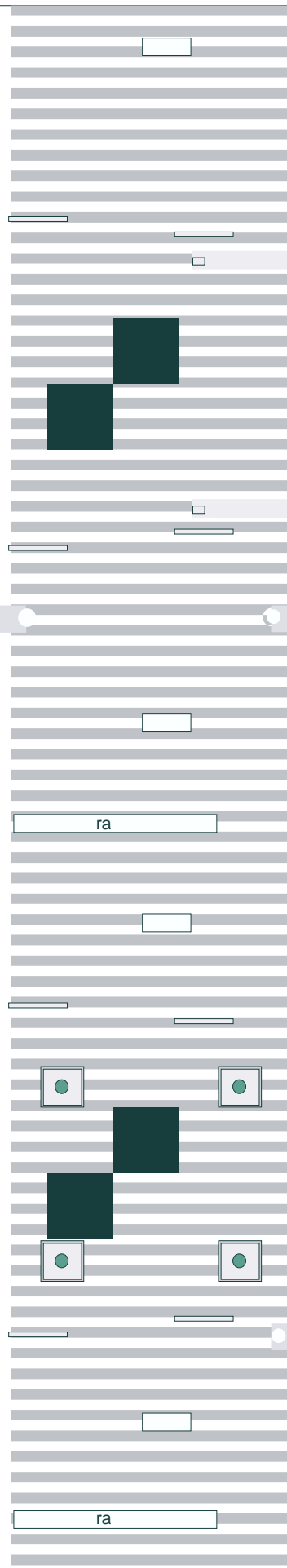

10 cm

© 2006 Designed by L.Cherkashyn This cardmodel is only for personal and not for commercial use

10 cm

10 cm

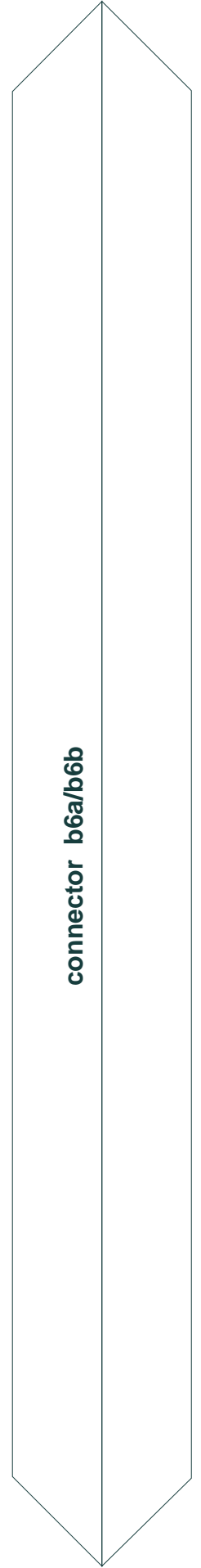
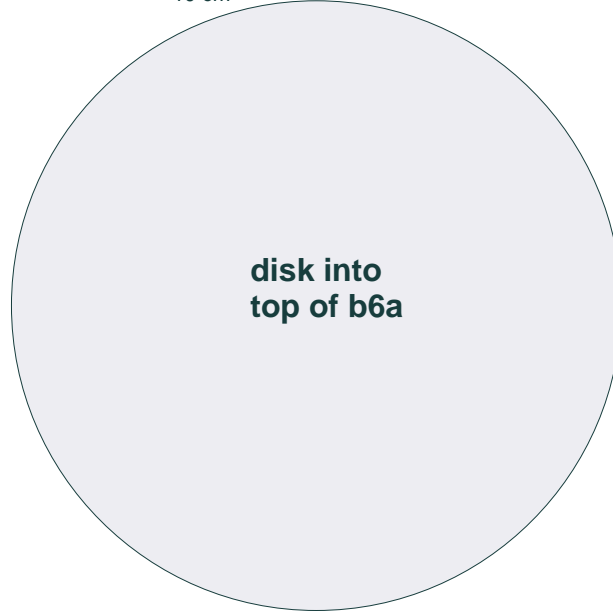
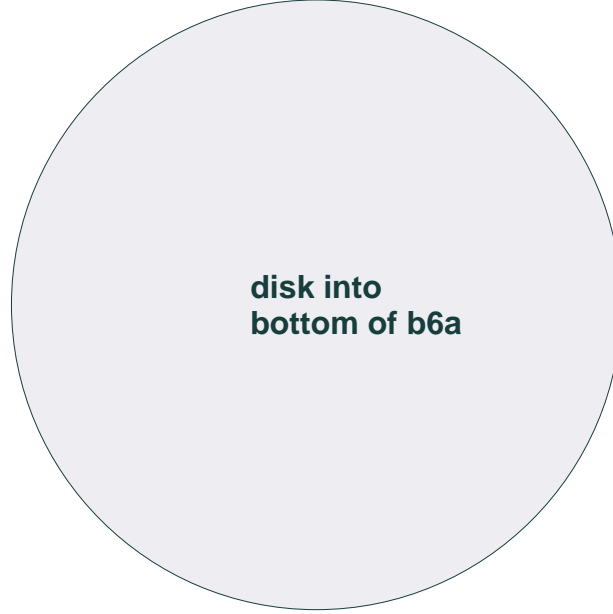
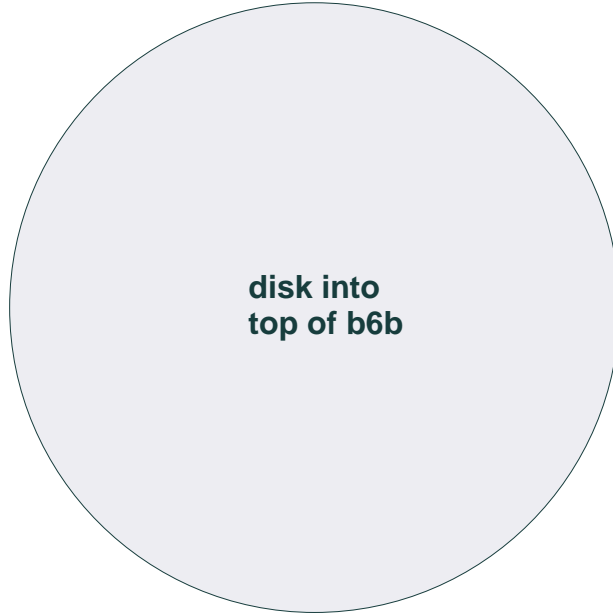
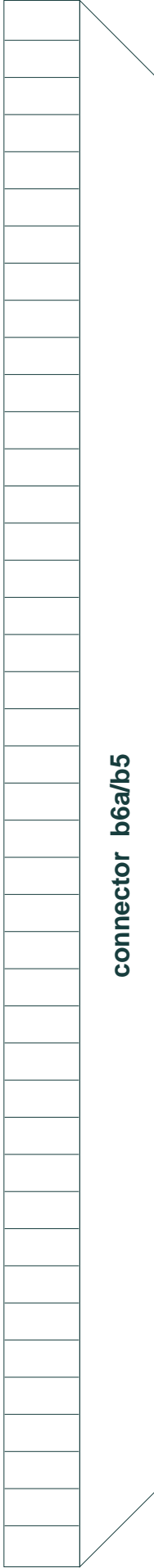

10 cm

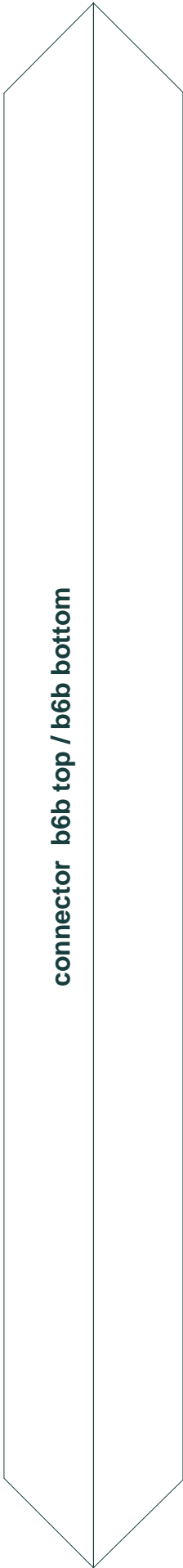
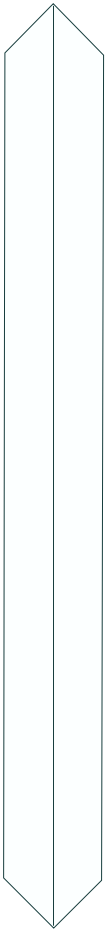

connector b6b top / b6b bottom

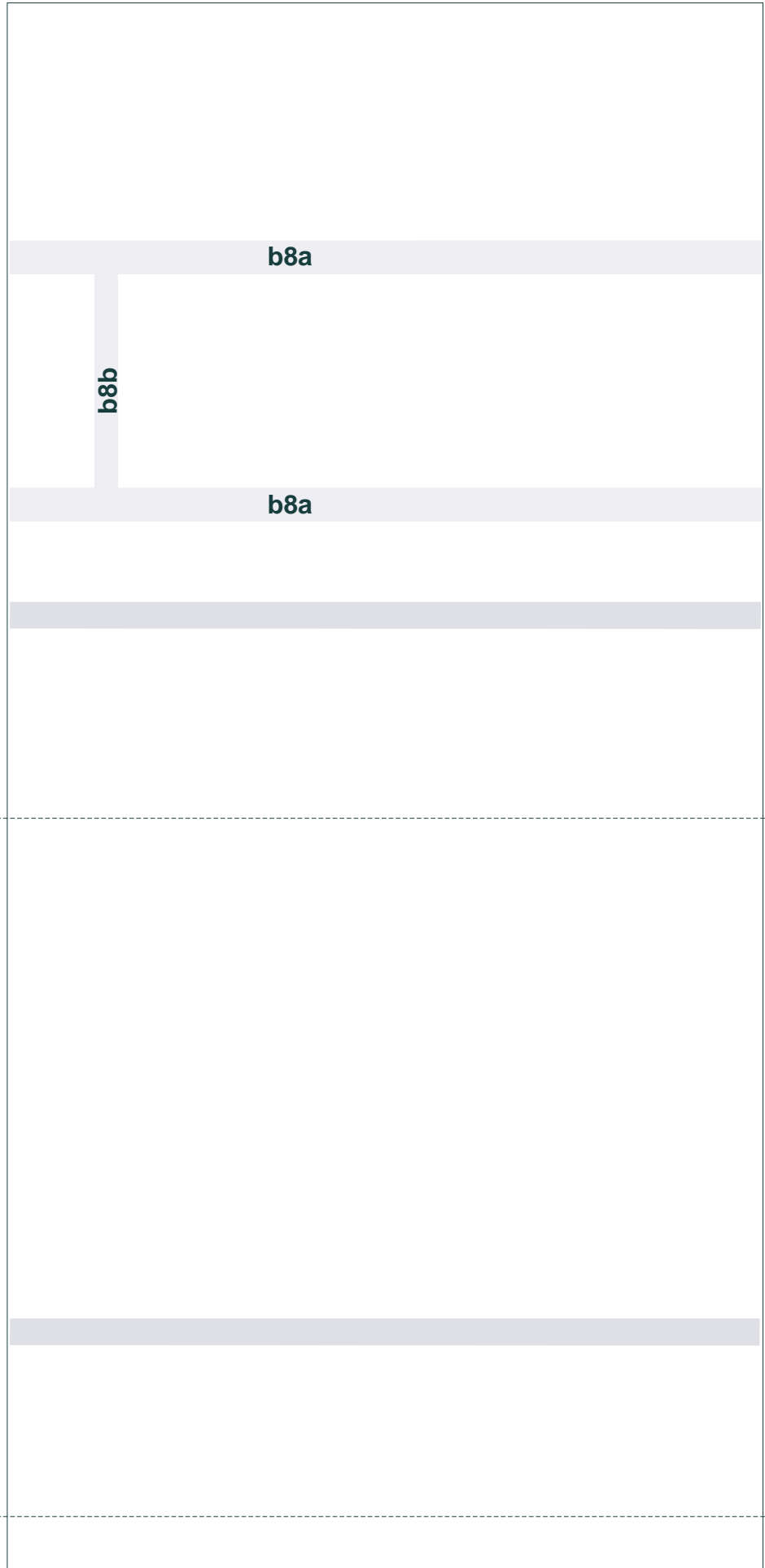

b8a

b8b

b8a



b6b bottom

base lines for assembling pairs of blocks A



connector b6b / b6 bottom



supporting ring for disk



supporting ring for disk

10 cm

b10

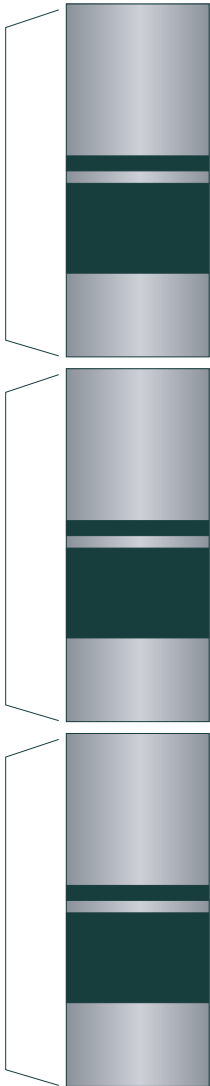

b7e optional

First necessary to cut along the broken line (1). The OUTER DUCT (2) of the figure to cut only after its gluing by connector 1.

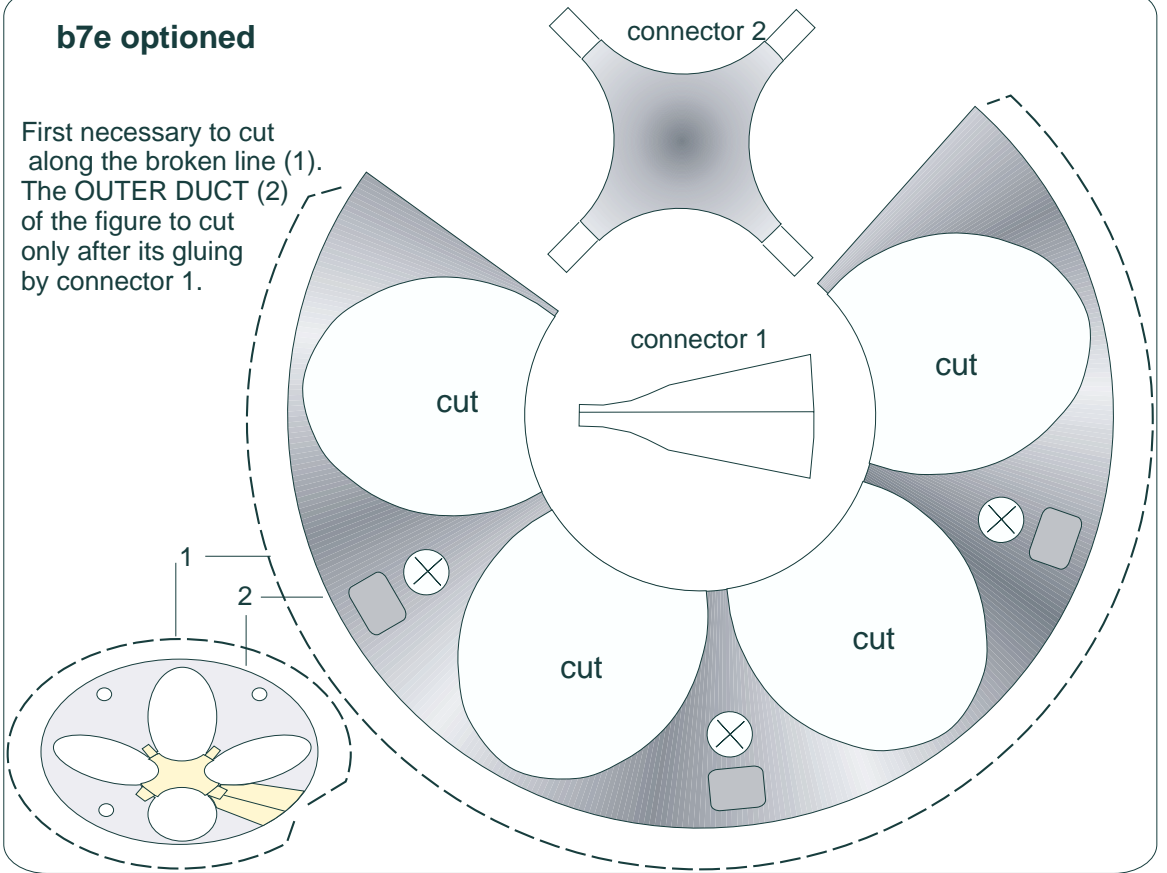

b22

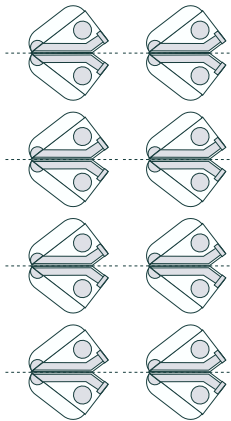

ra

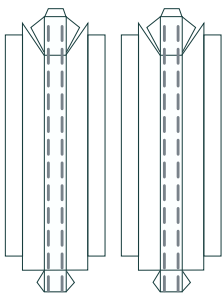

b9a

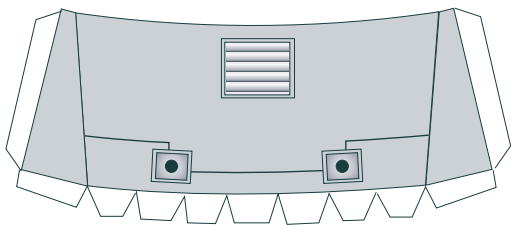

glue onto cardstock

b6 bottom disk

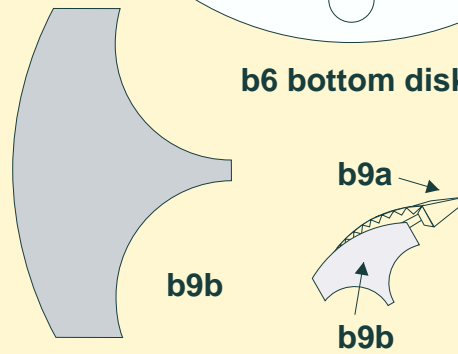

10 cm

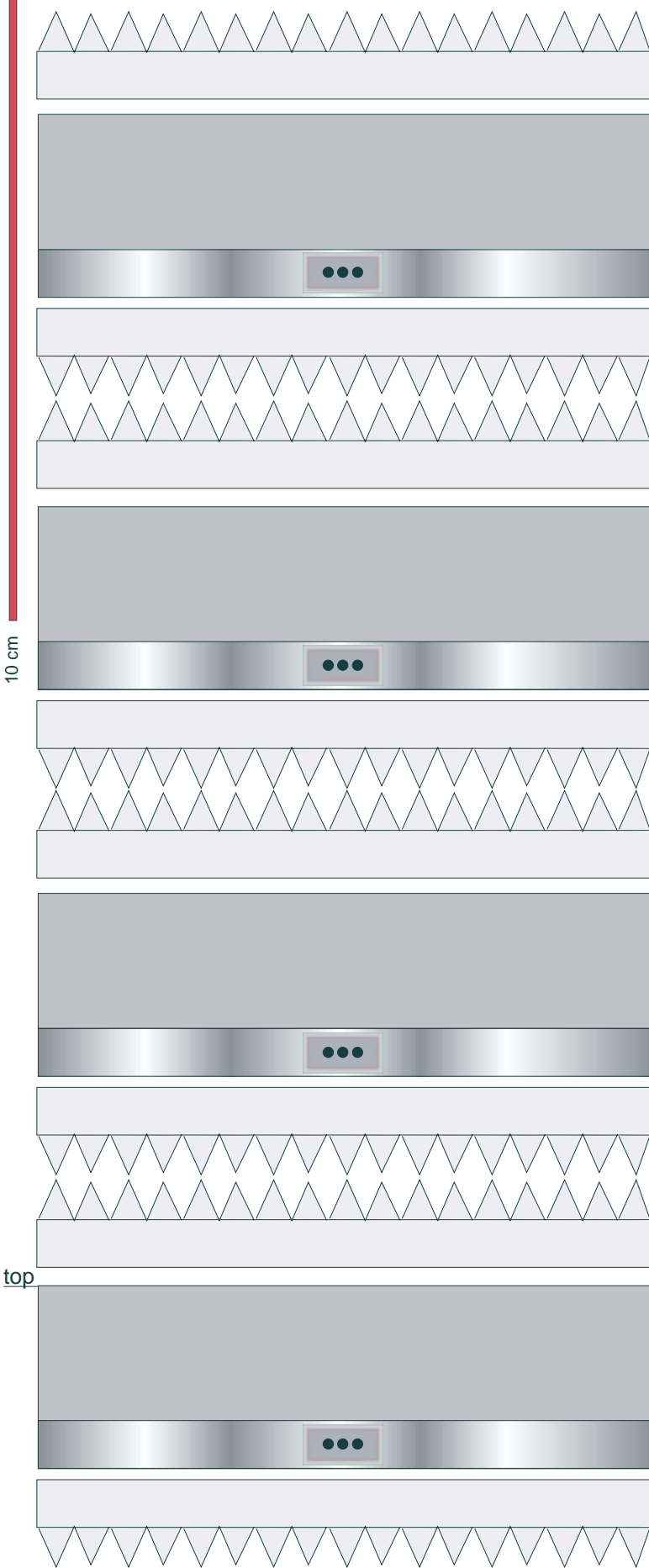

10 cm

top

b7d

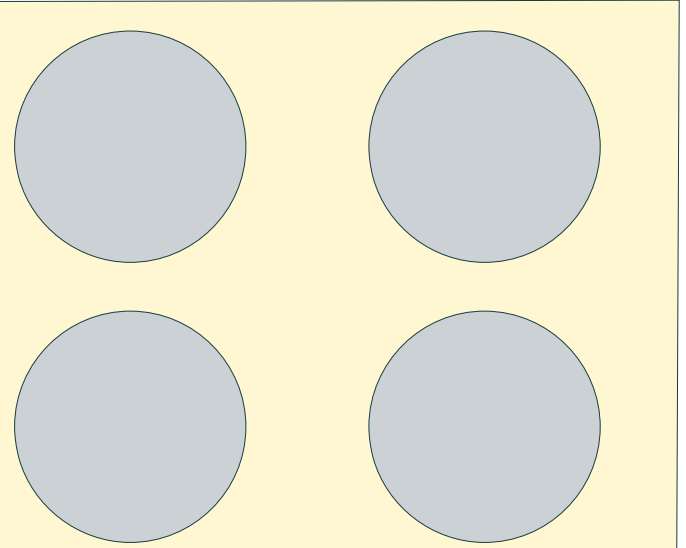

disks into b7d

glue onto cardstock

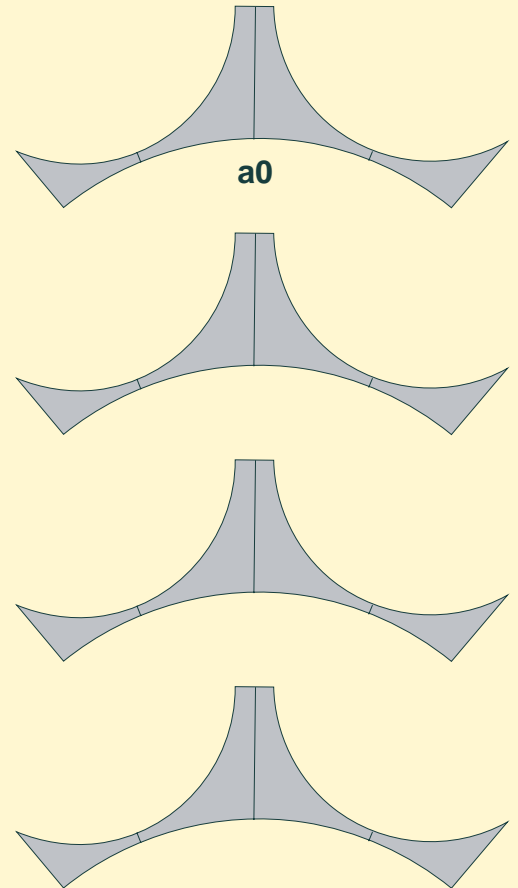

a0

b7c

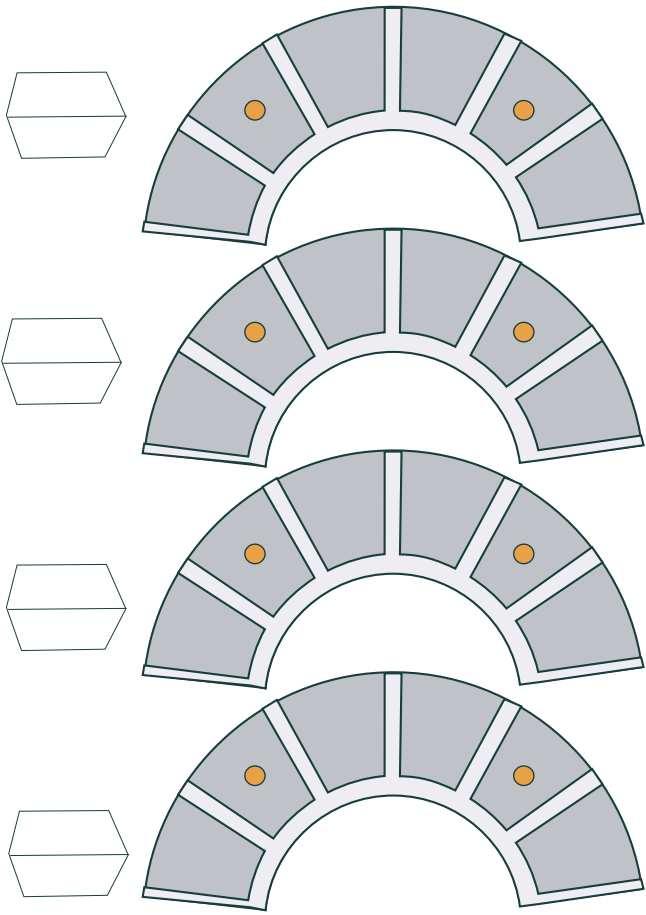

connectors b7b / b7c

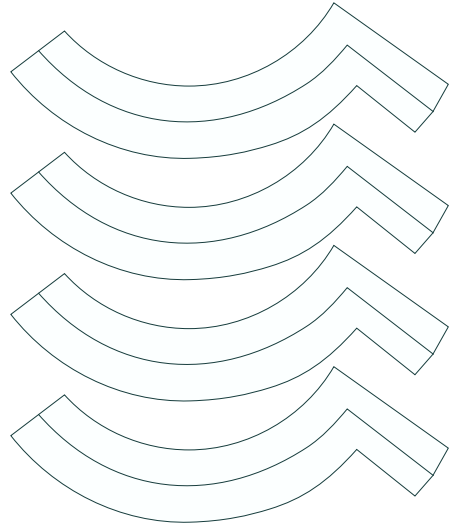

b7b

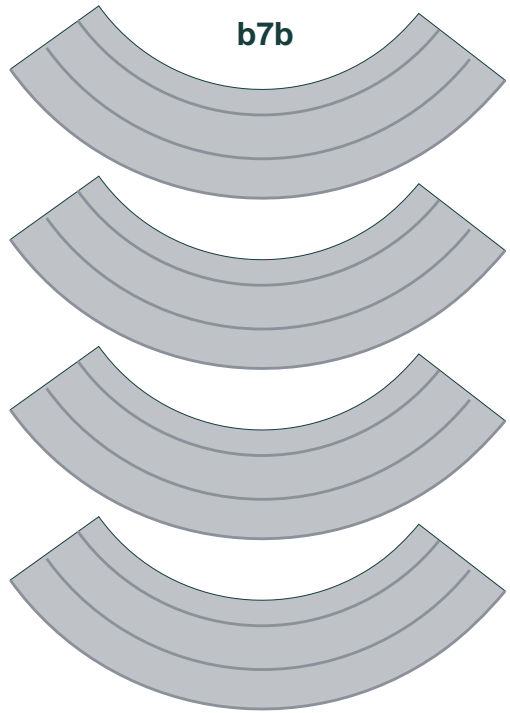

connectors b7a / b7b

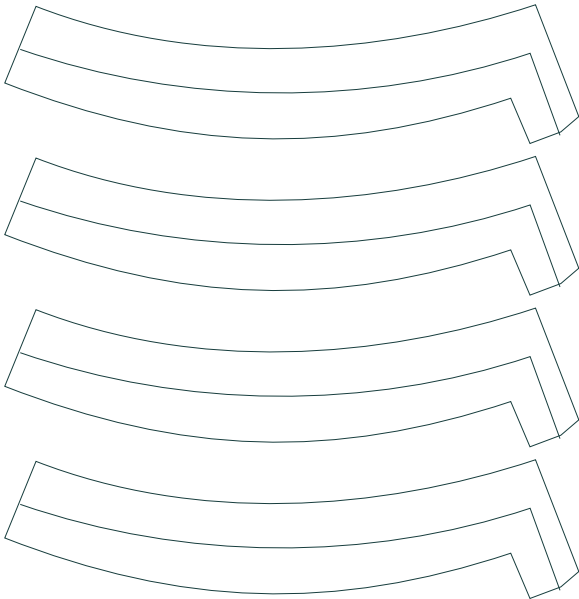

b7a

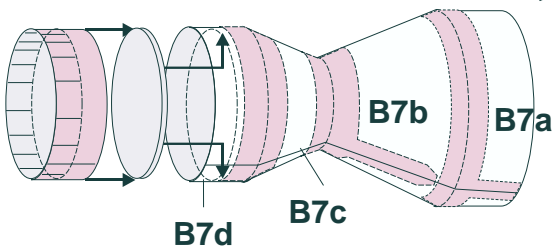
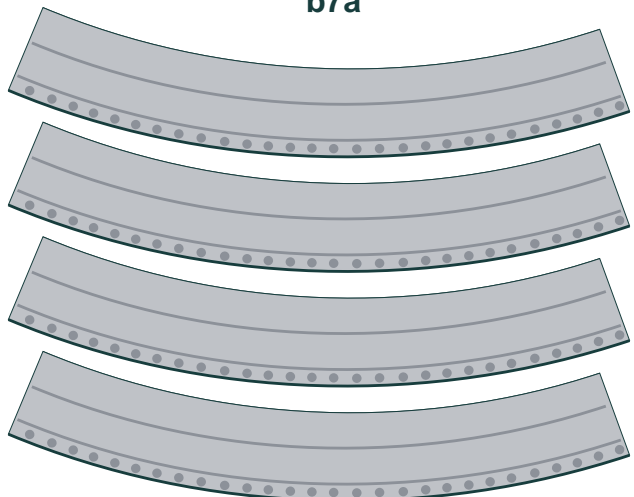

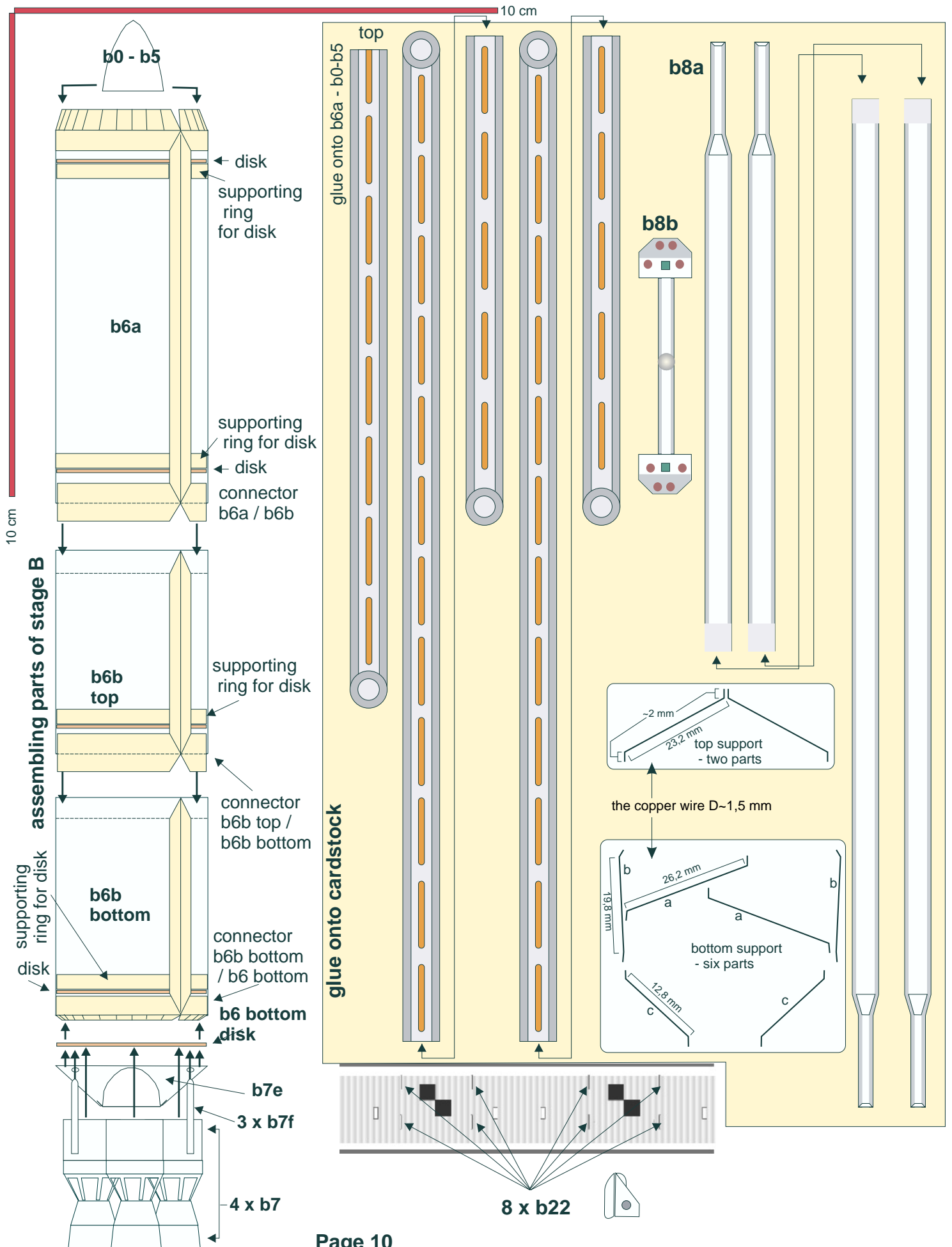

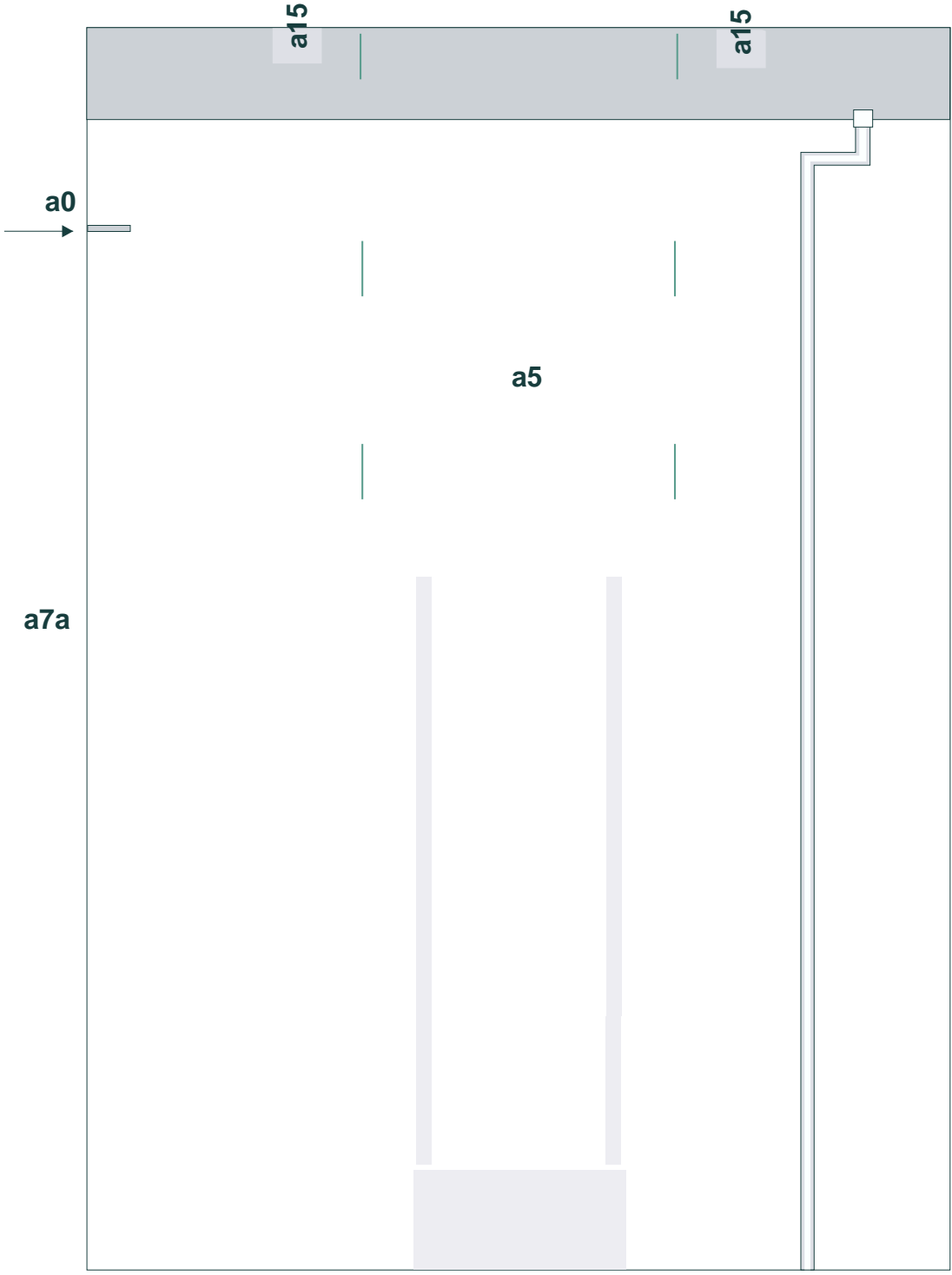
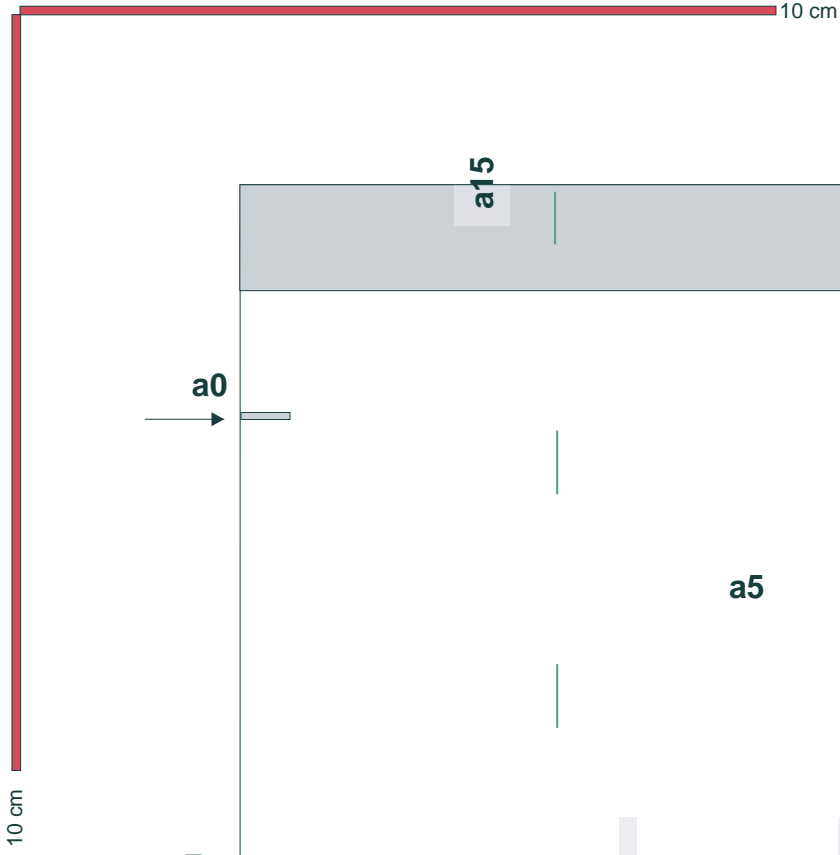

— slots

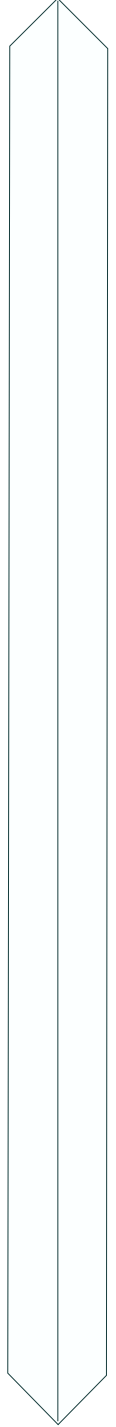

A1

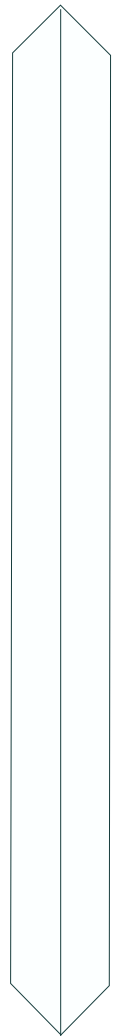
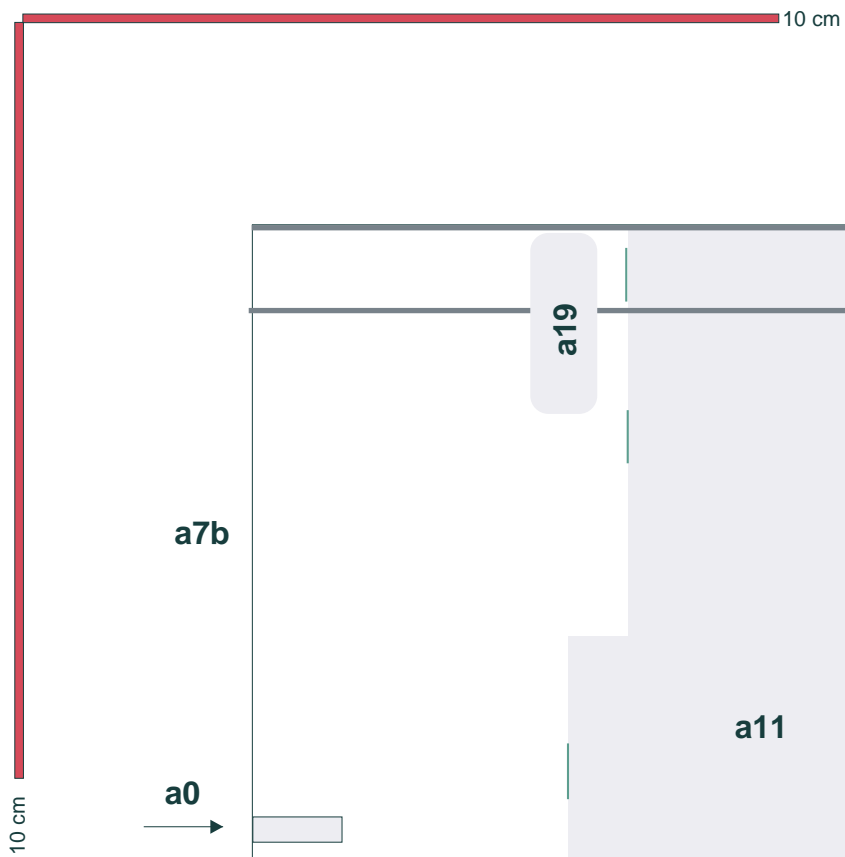

connector a7a / a7b

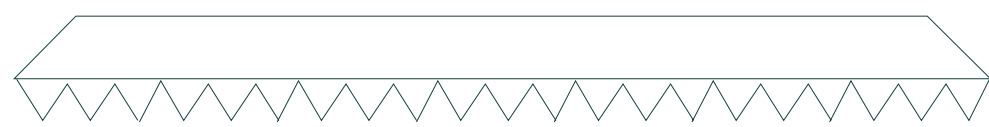

— slots

A1

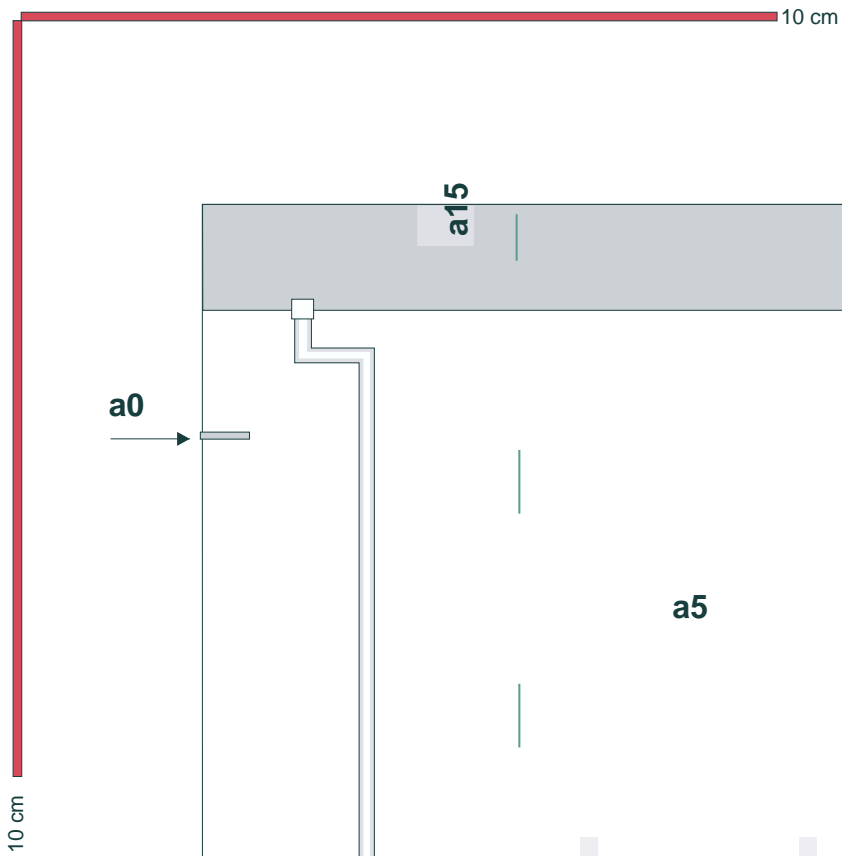

10 cm

10 cm

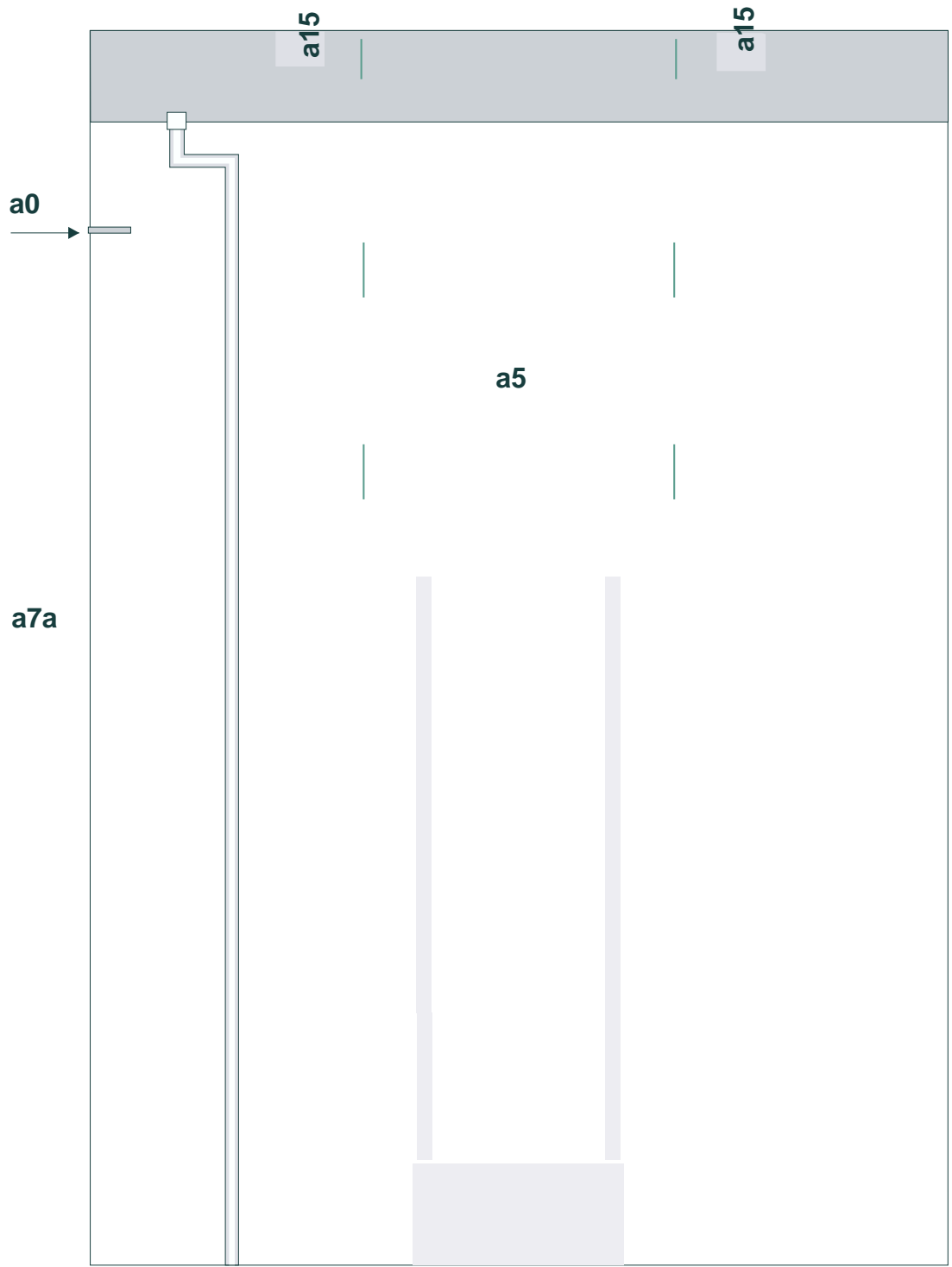

a0

a15

a15

a5

a7a

— slots

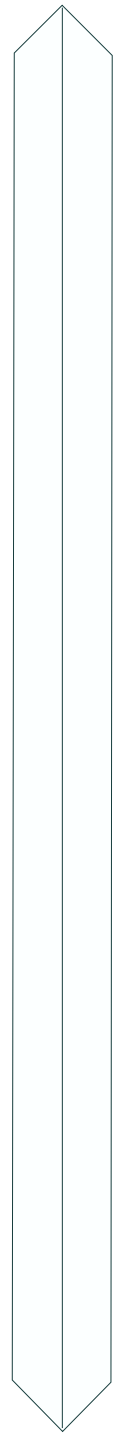

A2

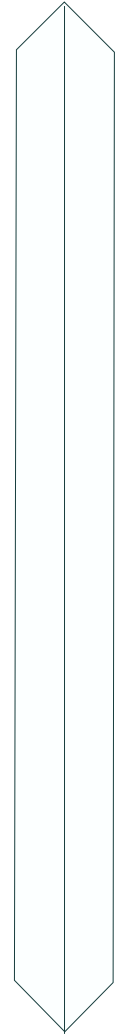

connector a7a / a7b

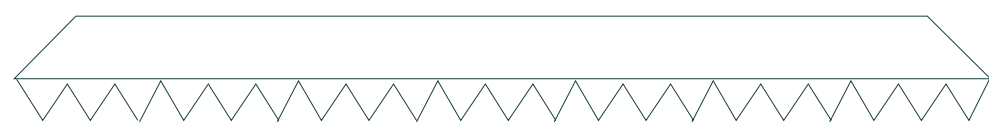

— slots

A2

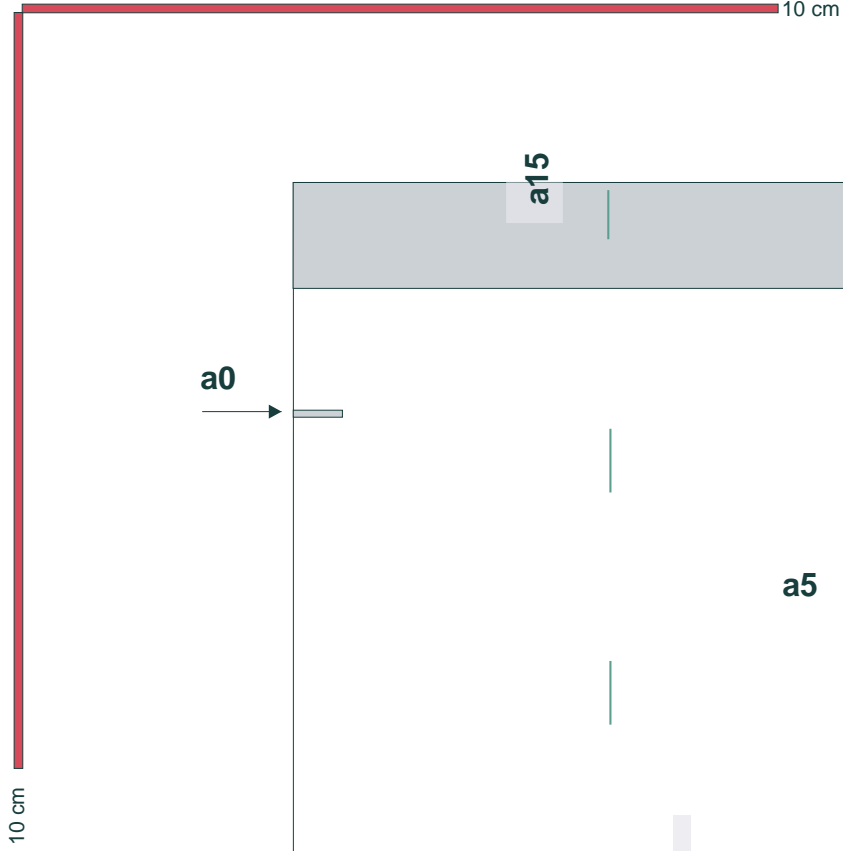

A3

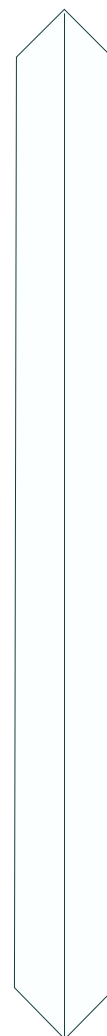
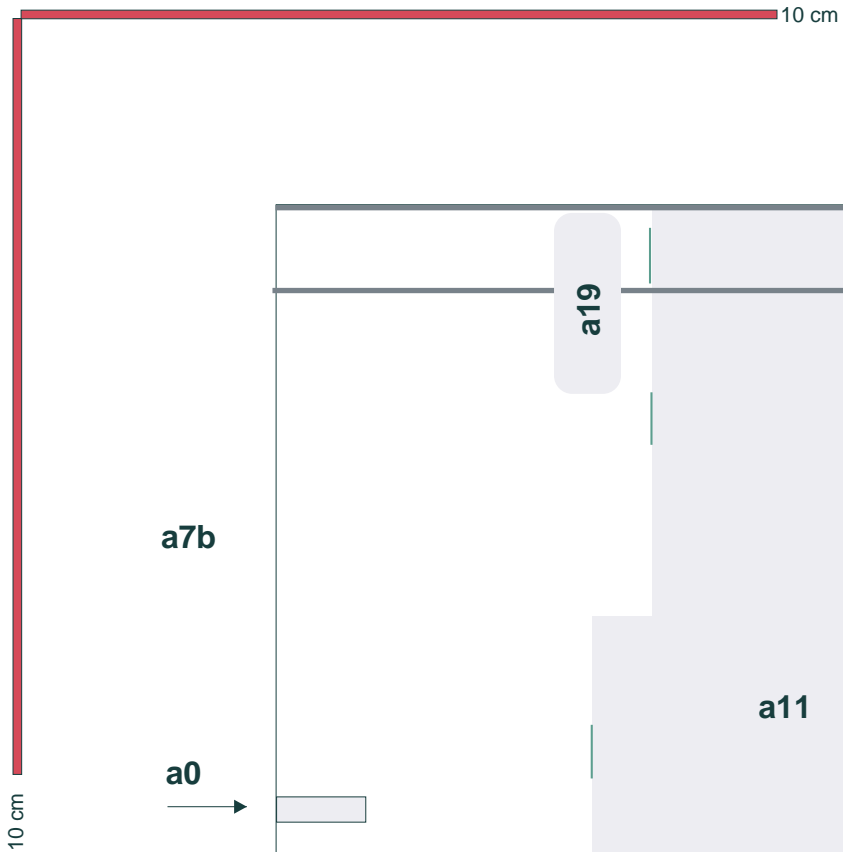

connector a7a / a7b

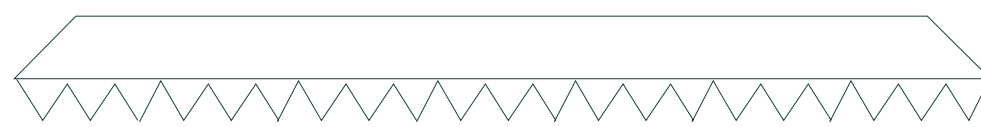

— slots

A3

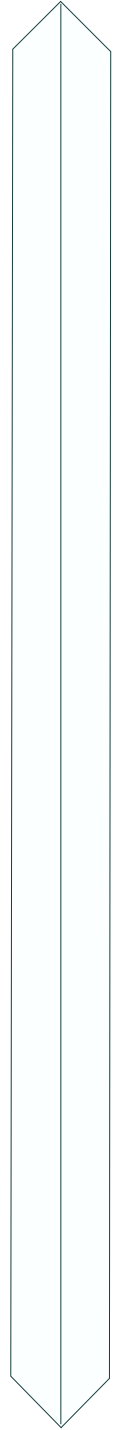
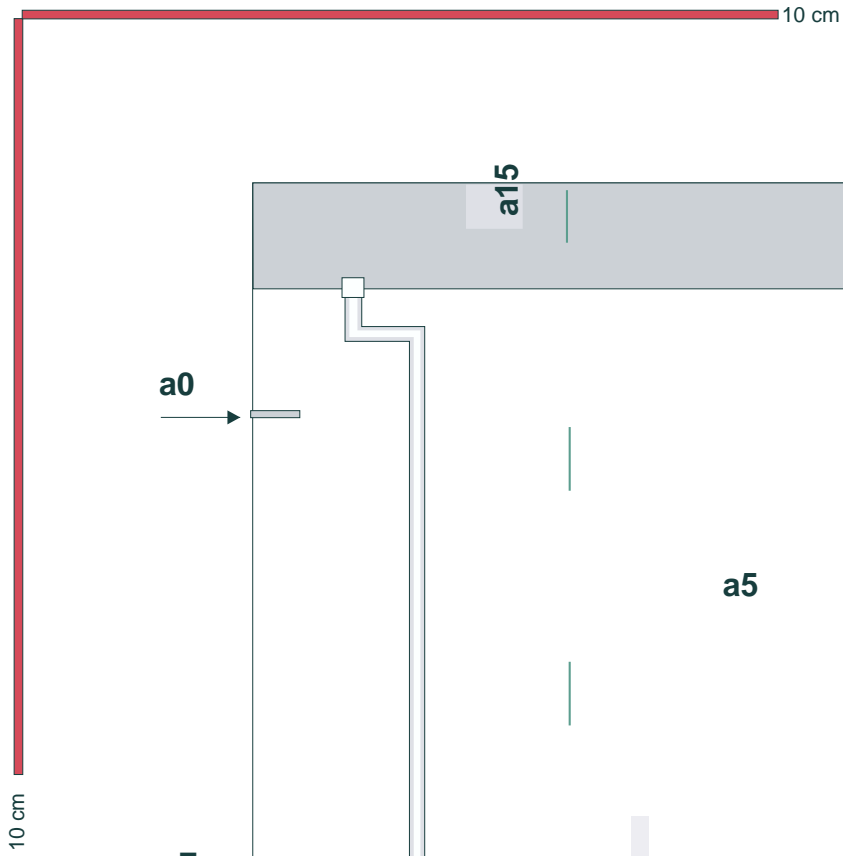

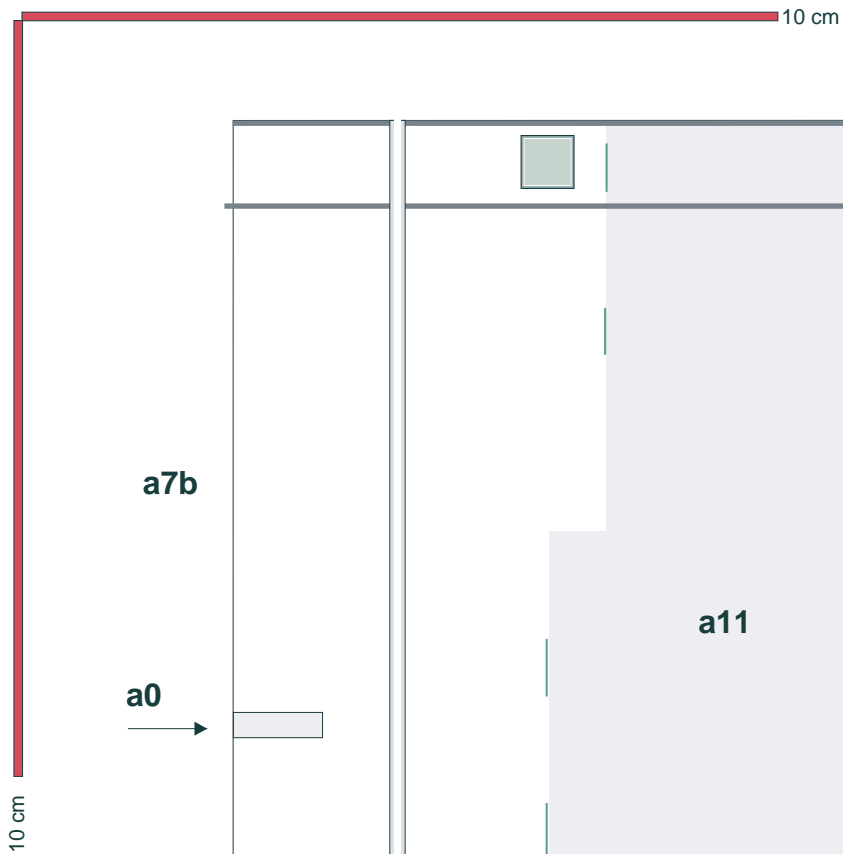

connector a7a / a7b



— slots

A4

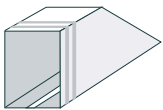
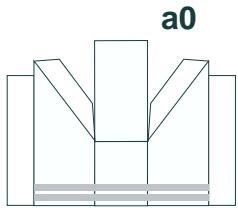
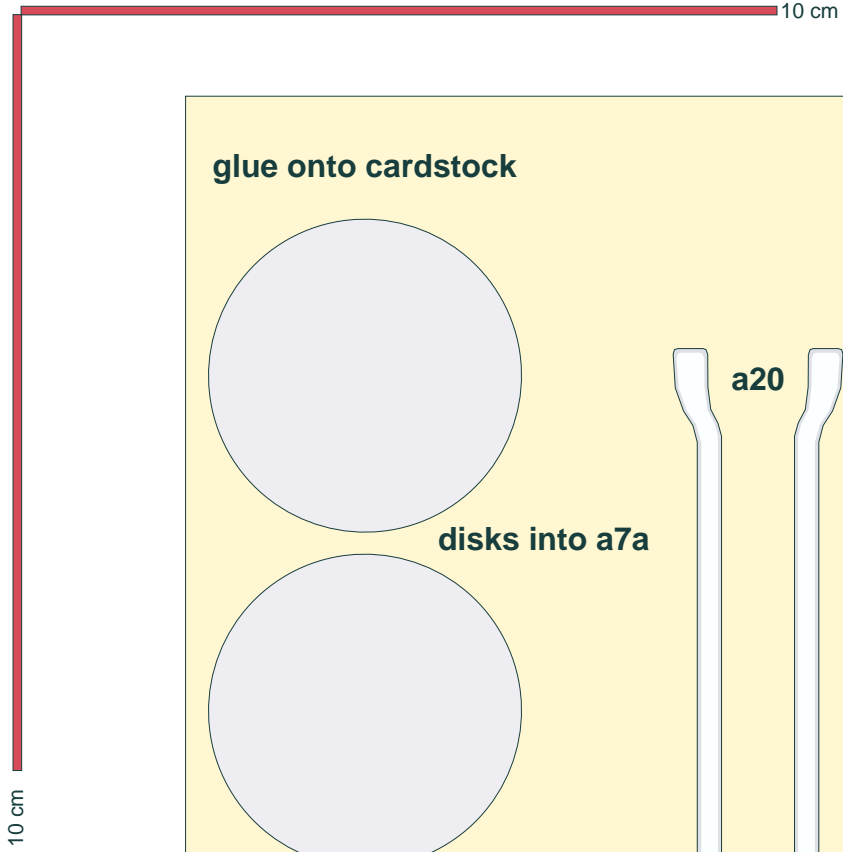

Details for stage A
Print 4 copies

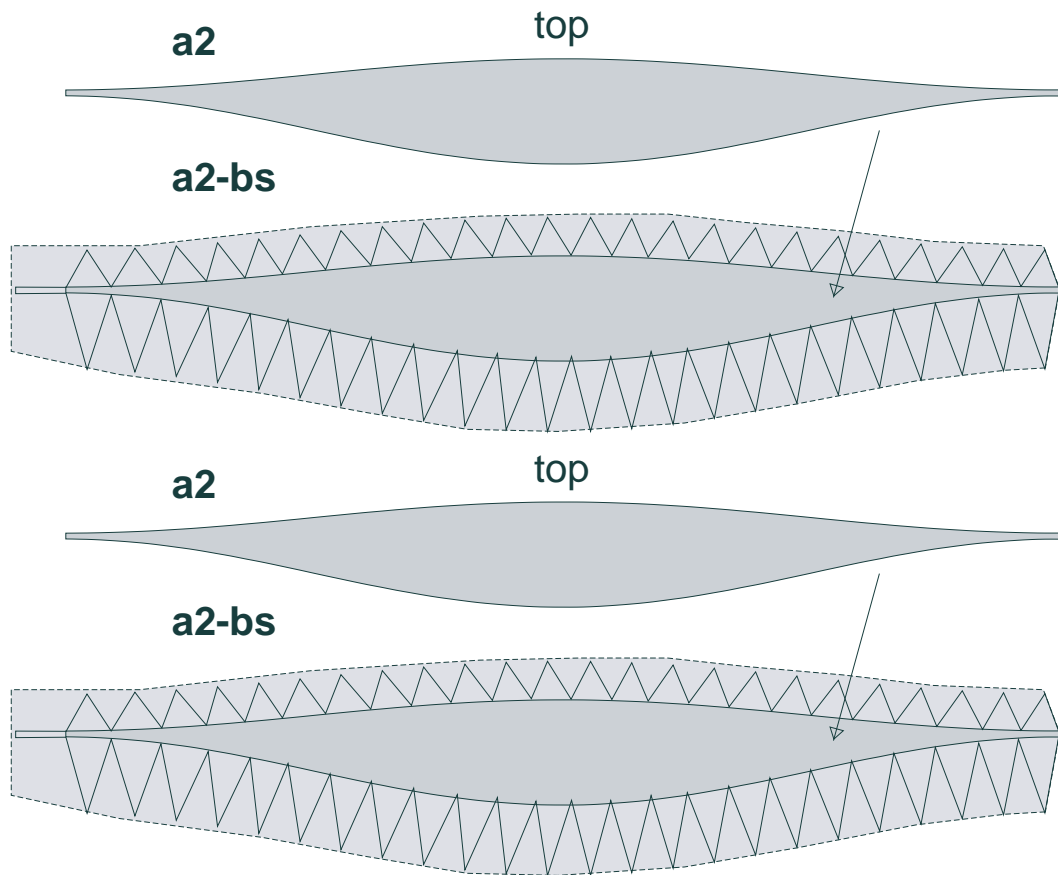
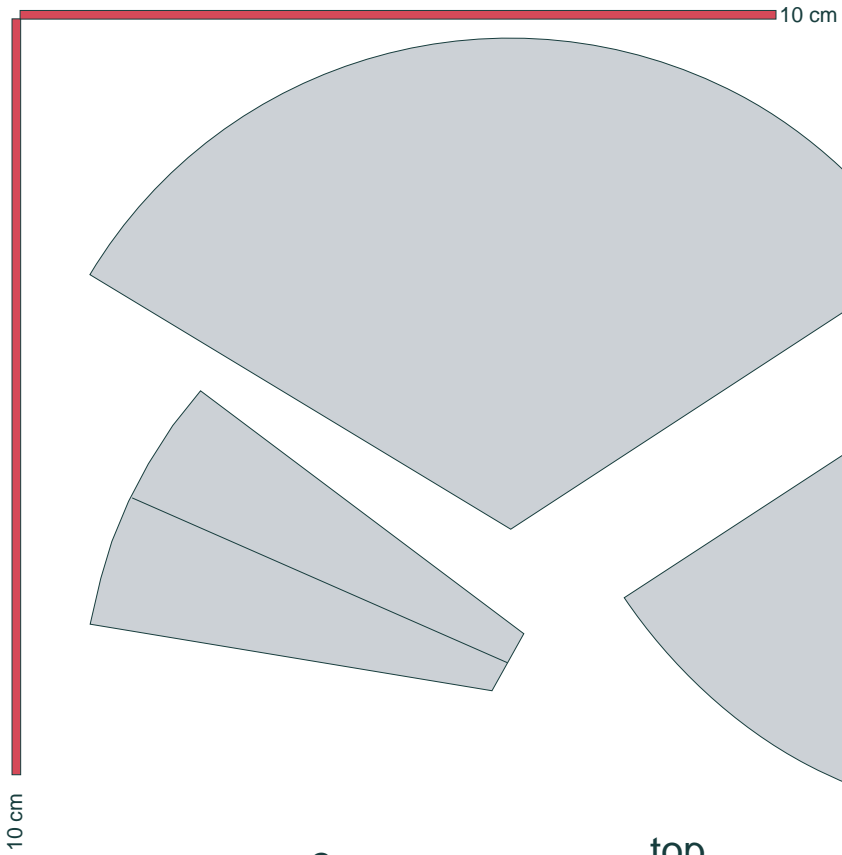

Top cones of busters A2 & A3

Glue part a2 onto a2-bs and immediately (before glue dry up) roll as semitubes. Take it by hard cylinder on soft (porous) surface from back side. Then glue a2 as a tube. Cut tothing only on dry one.

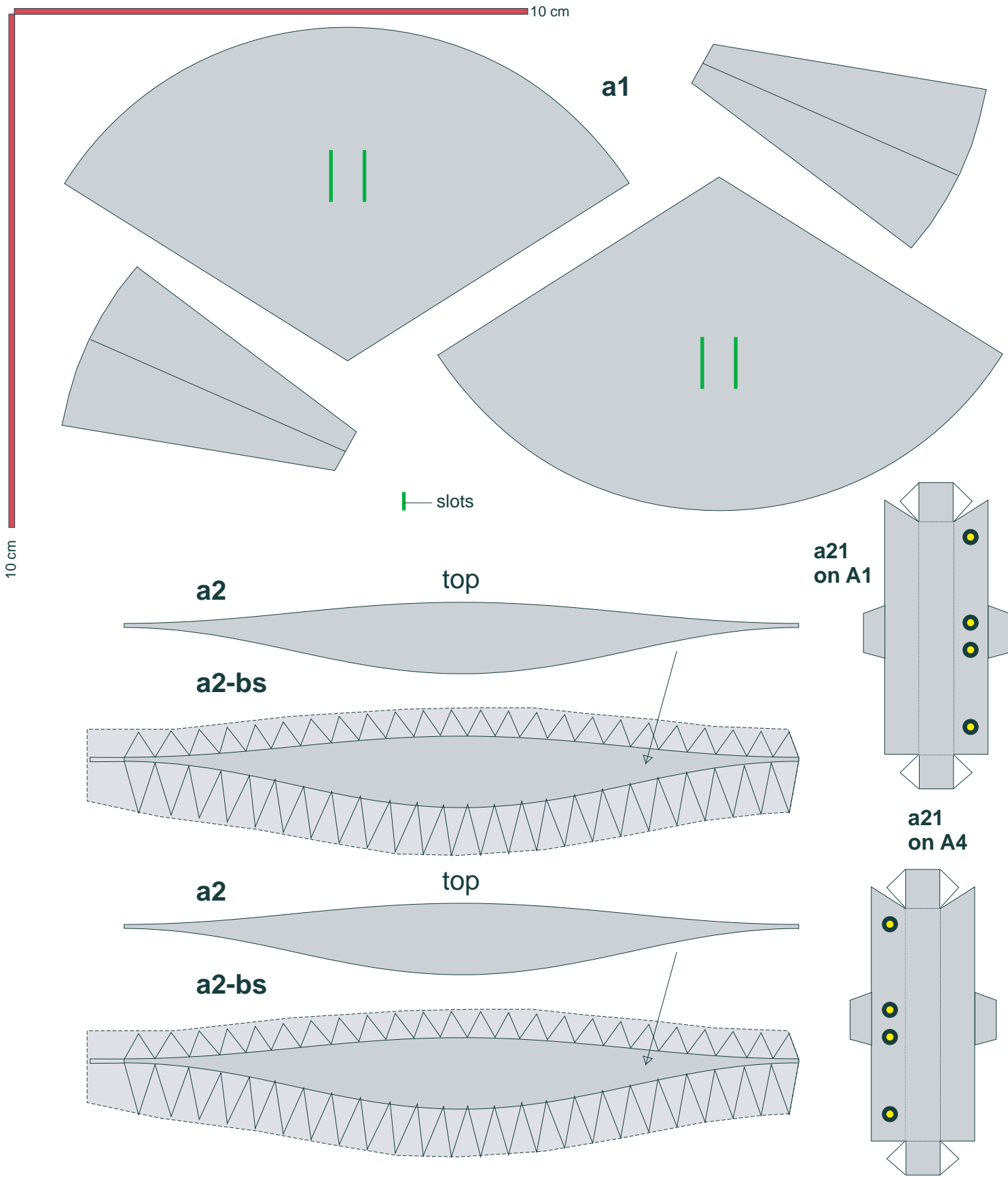

Top cones of busters A1 & A4

Glue part a2 onto a2-bs and immediately (before glue dry up) roll as semitubes. Take it by hard cylinder on soft (porous) surface from back side. Then glue a2 as a tube. Cut tootingh only on dry one.

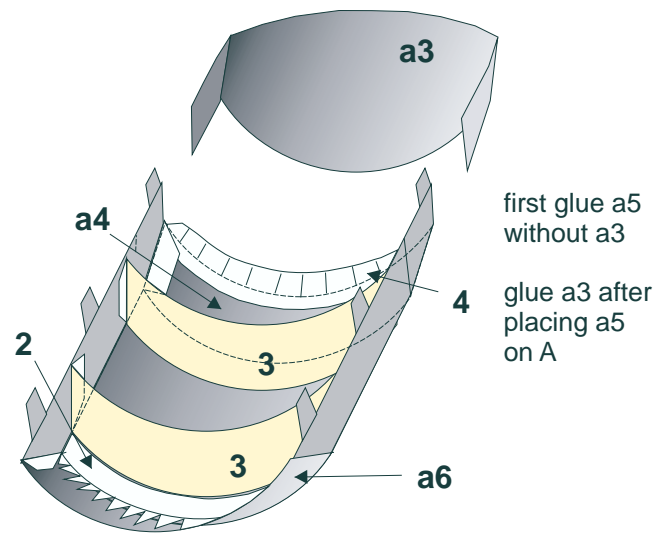
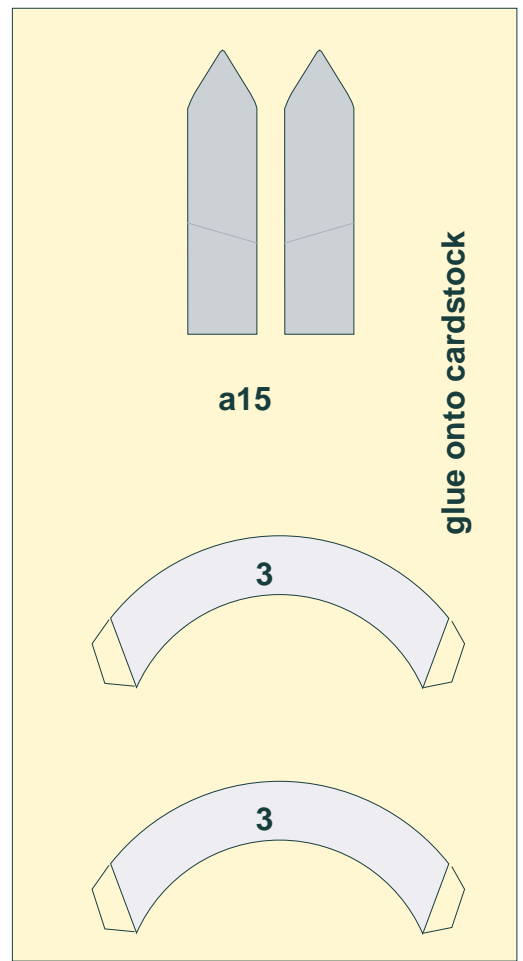
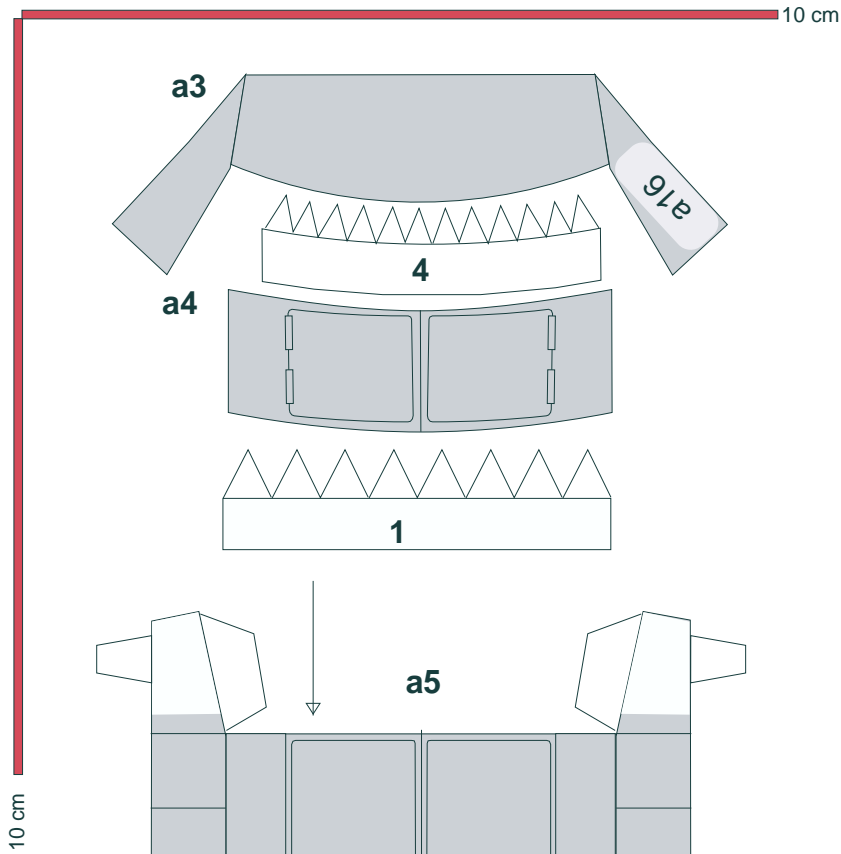

assembling of top part of saving system

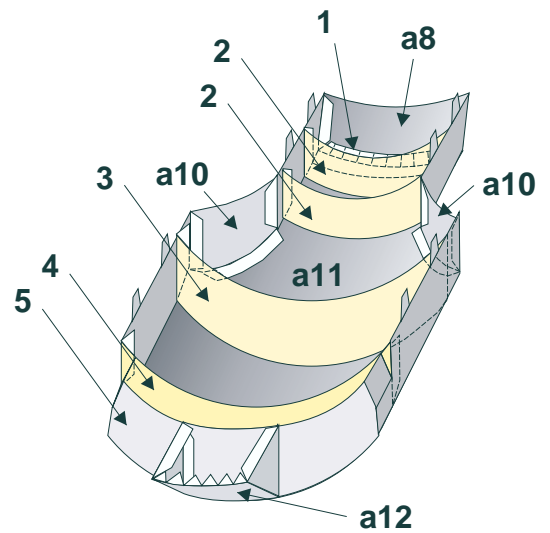
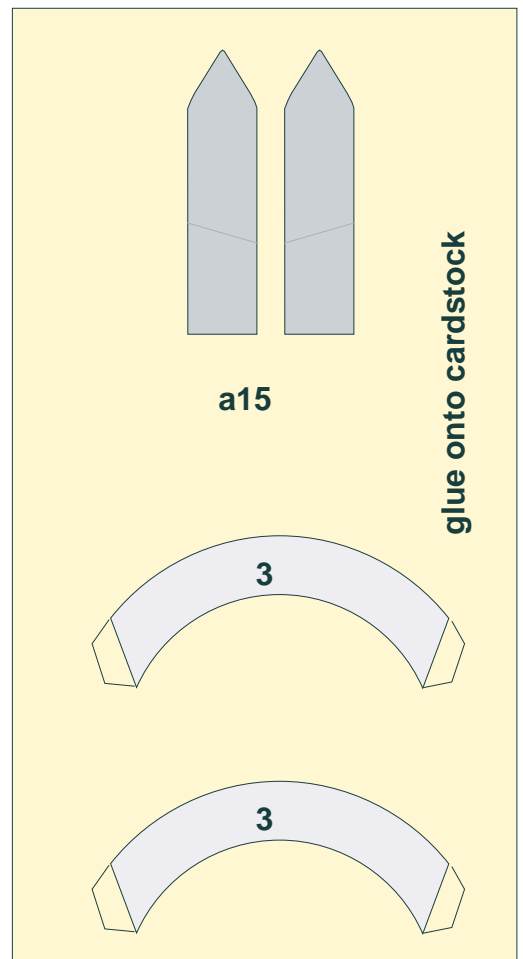
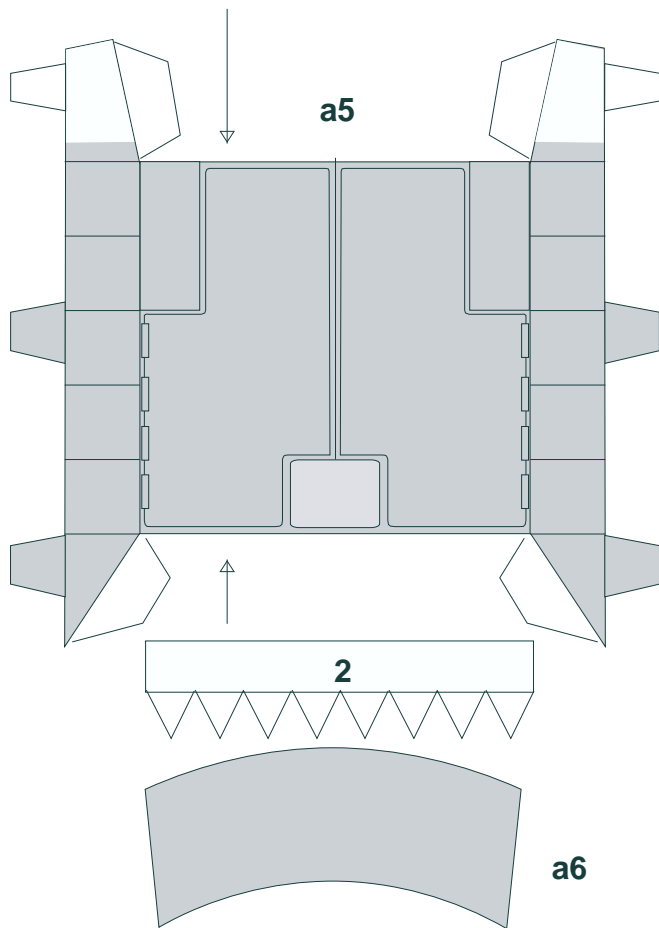
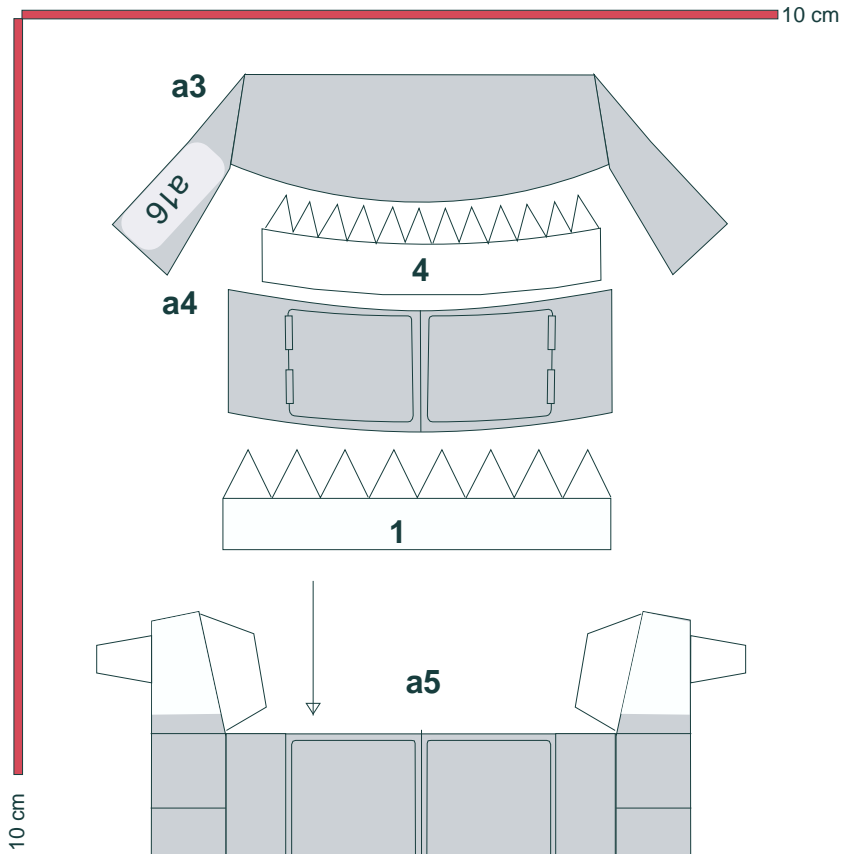

assembling of bottom part of saving system (see p.23)

10 cm

10 cm

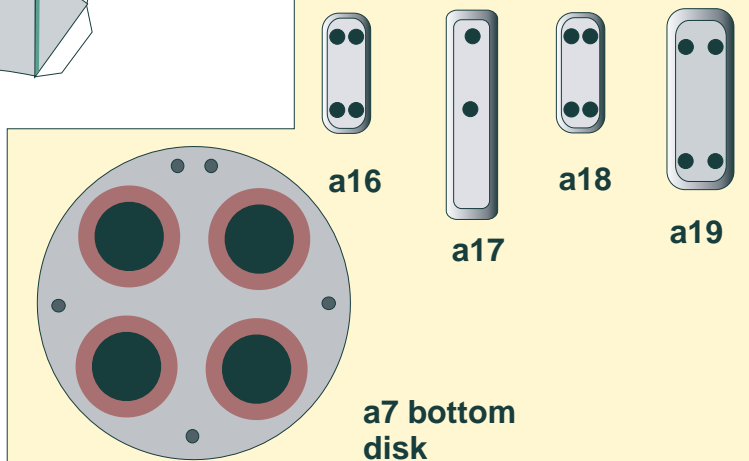
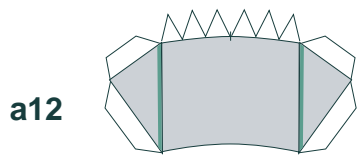
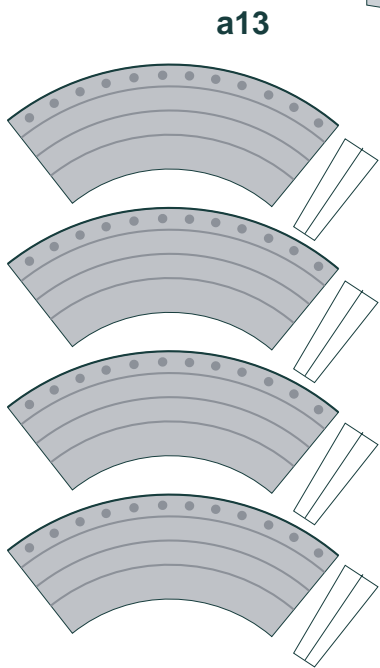
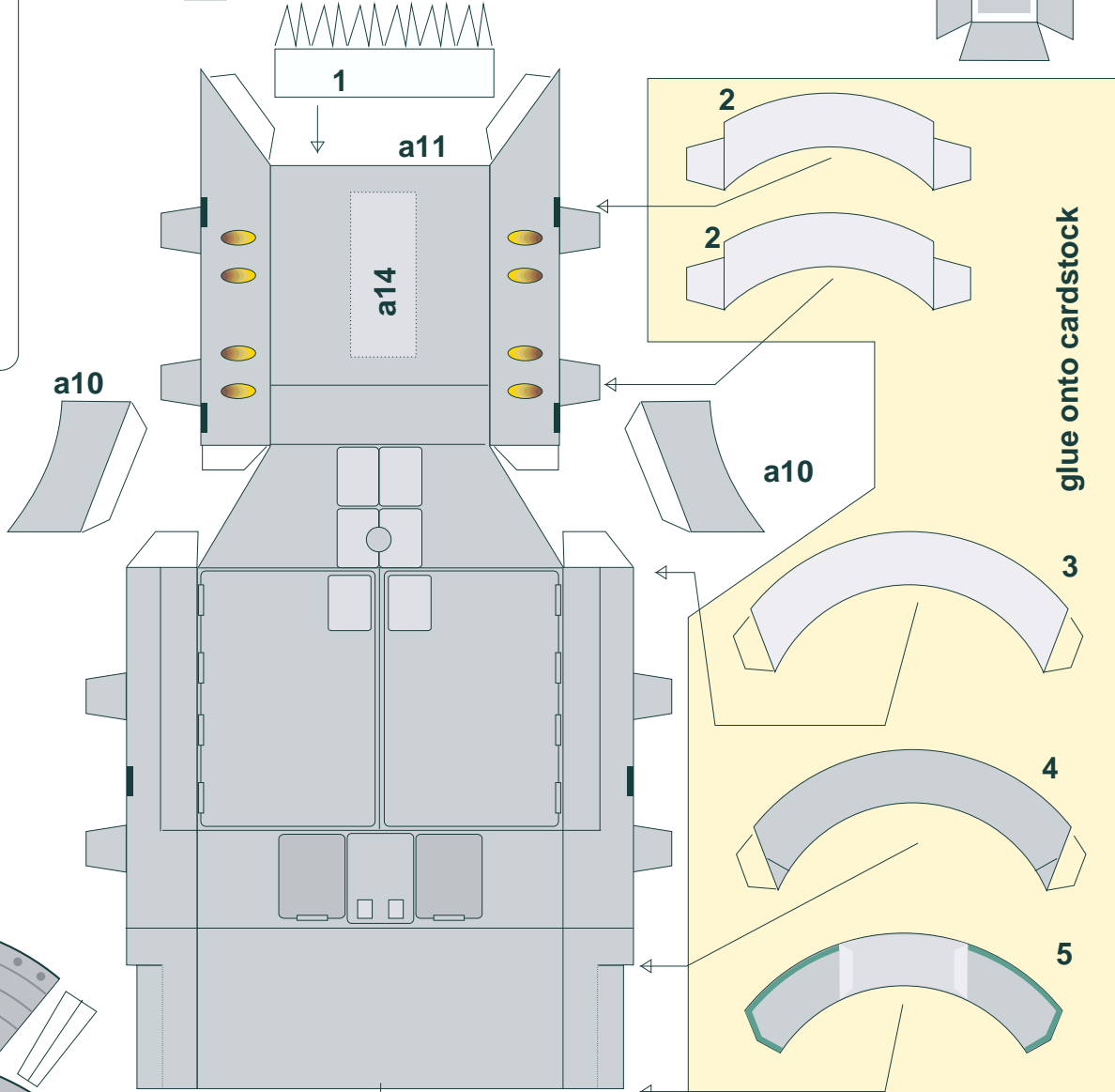
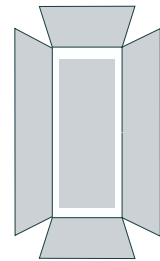
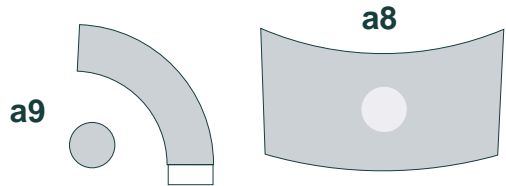
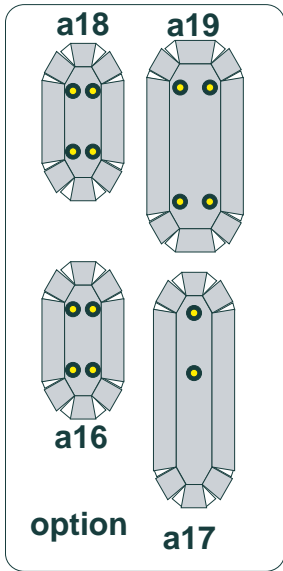

assembling A to B

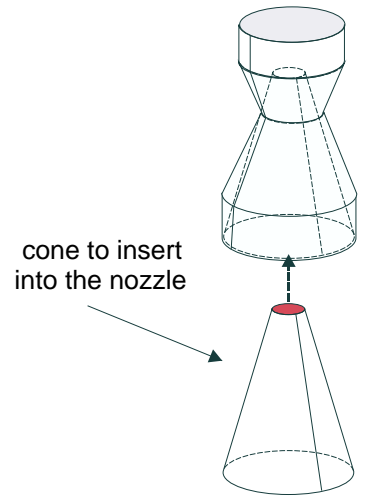
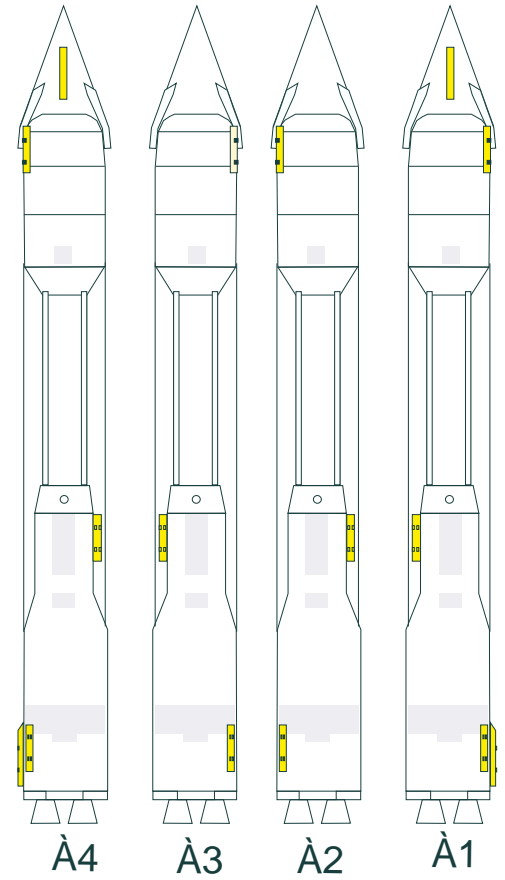
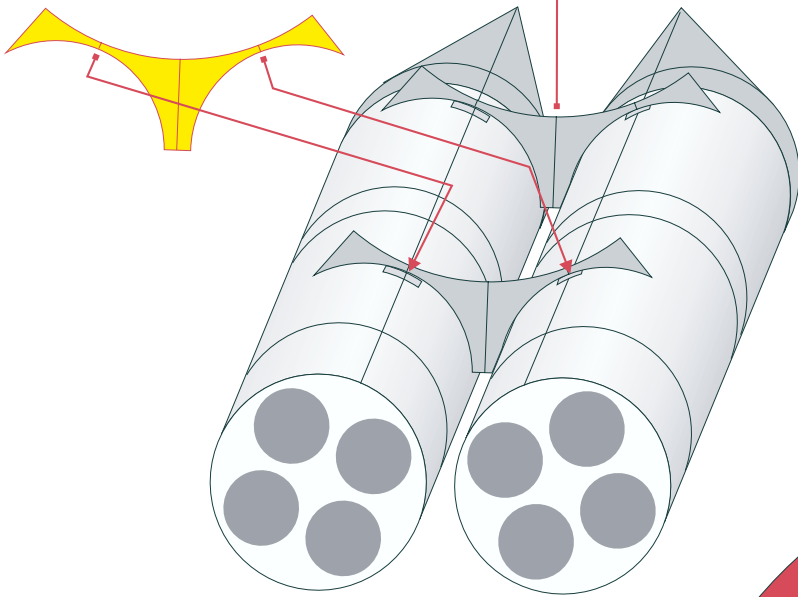
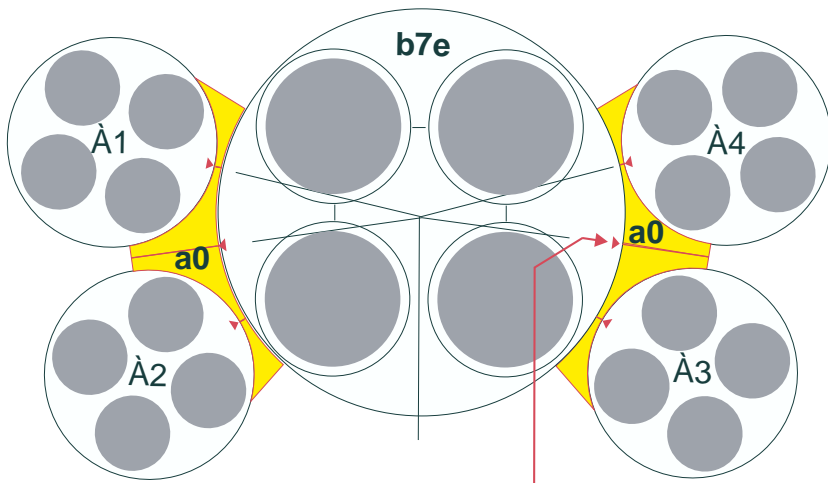

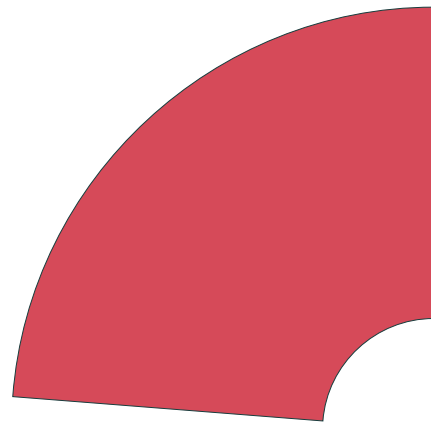
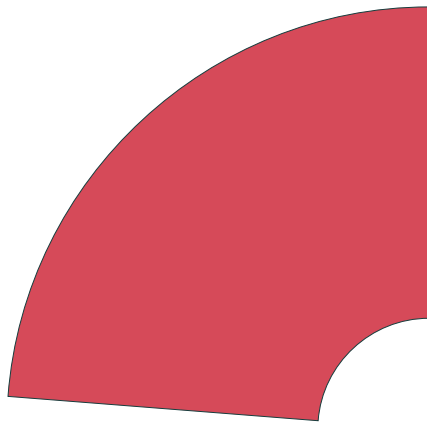
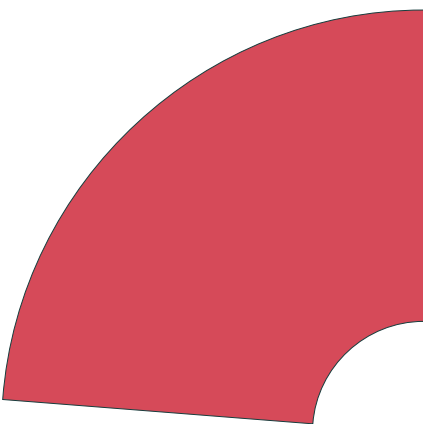

Glue parts a0 to A using markers "a0" on A, then glue pairs of blocks A on B, using markers "a0" on B. Ends of the nozzles of all blocks - in common plane.

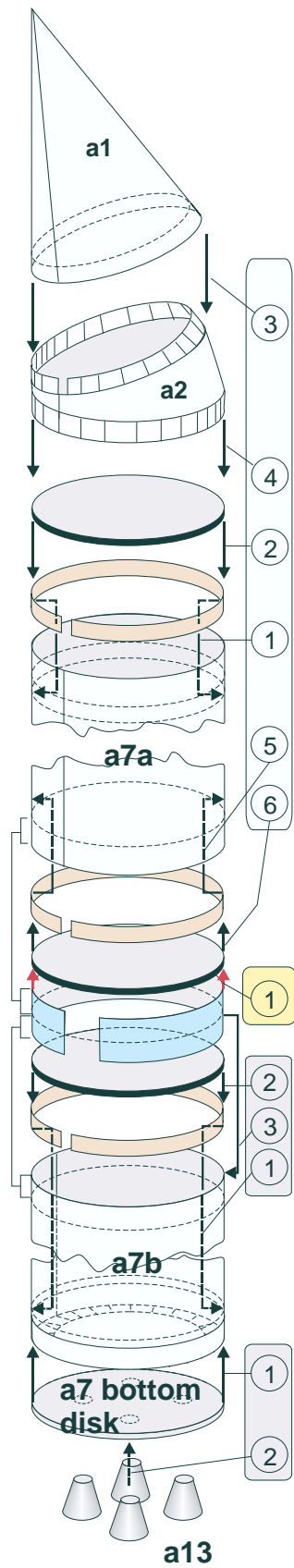



steps of assembling parts of body stage A

 supporting rings
 connecting ring
 slots

last step of assembling body of stage A

assembling supports for payload on body of stage B

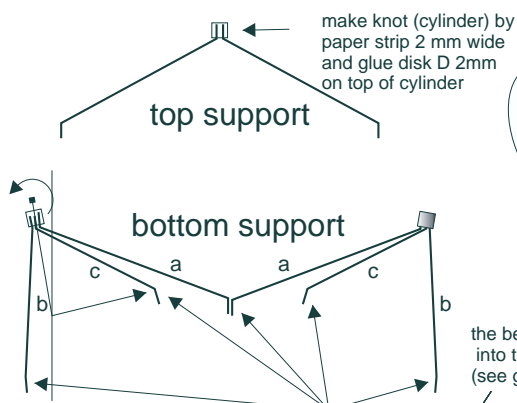

the bent back ends paste into the holes on part B (see green marks)

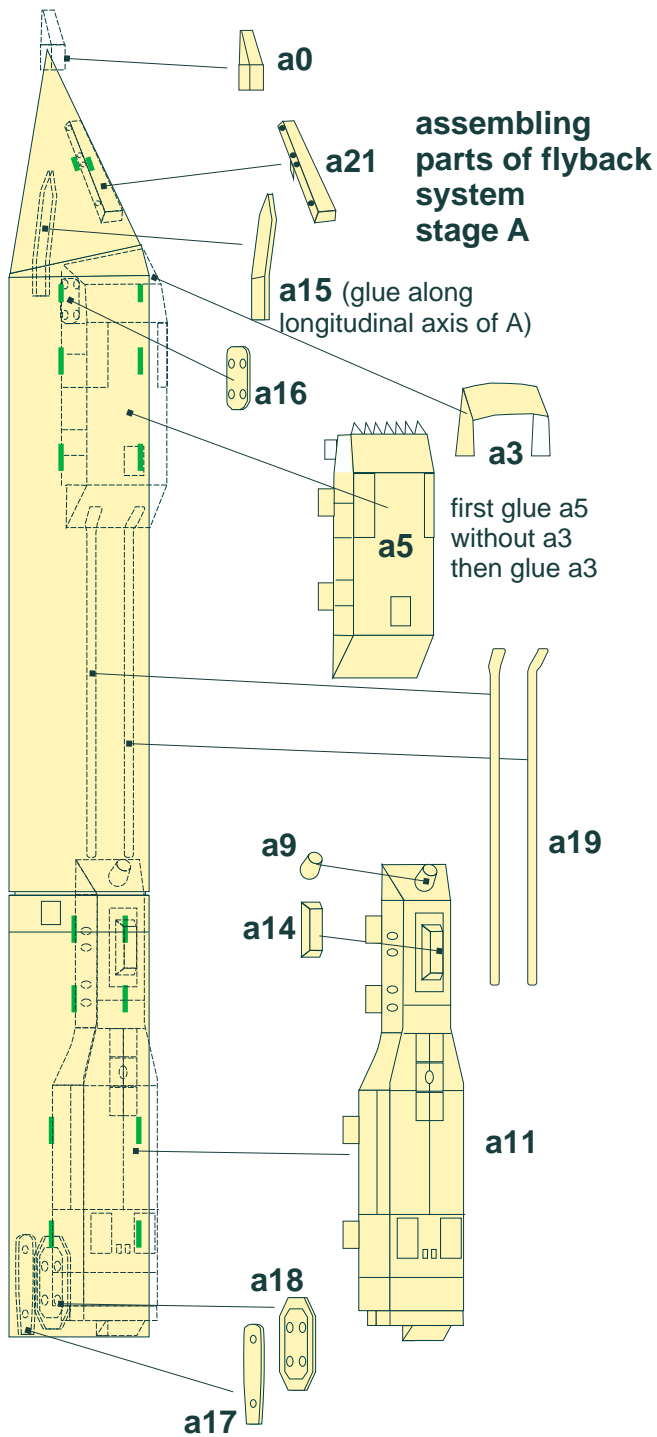

assembling parts of flyback system stage A

first glue a5 without a3 then glue a3

Template for assembling of Stages A & B

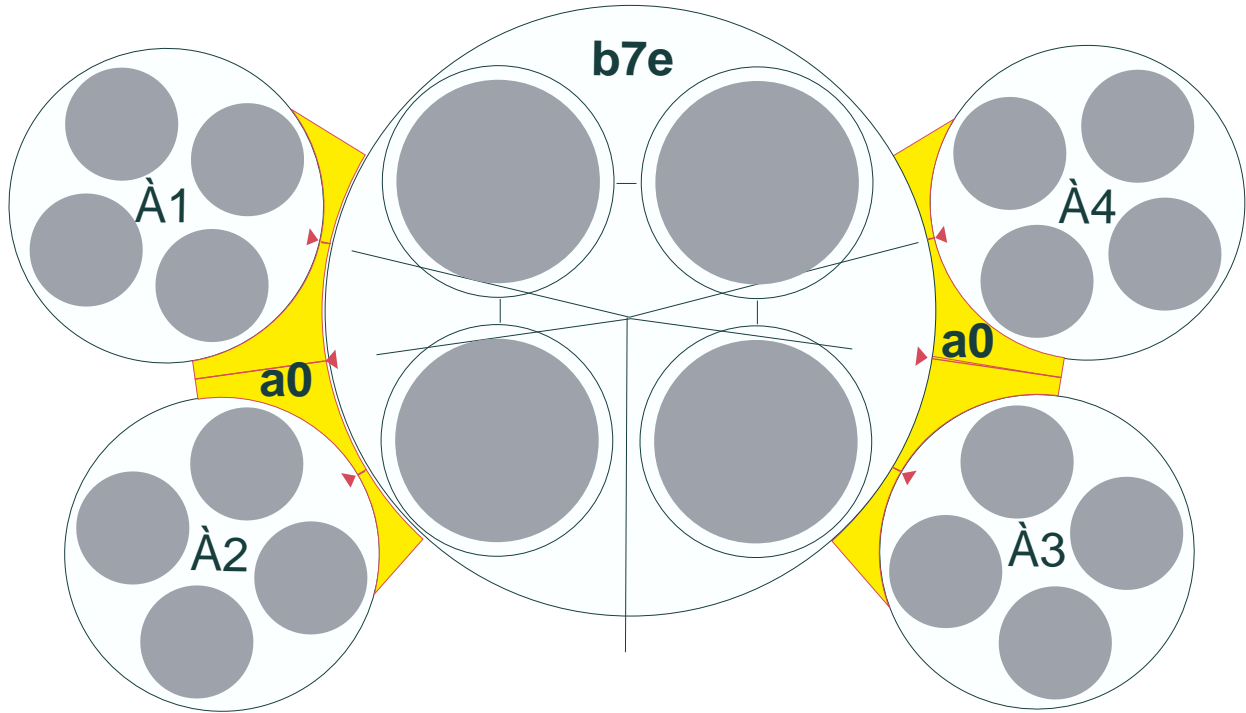

10 cm