

# Energia - M

1:96 scale

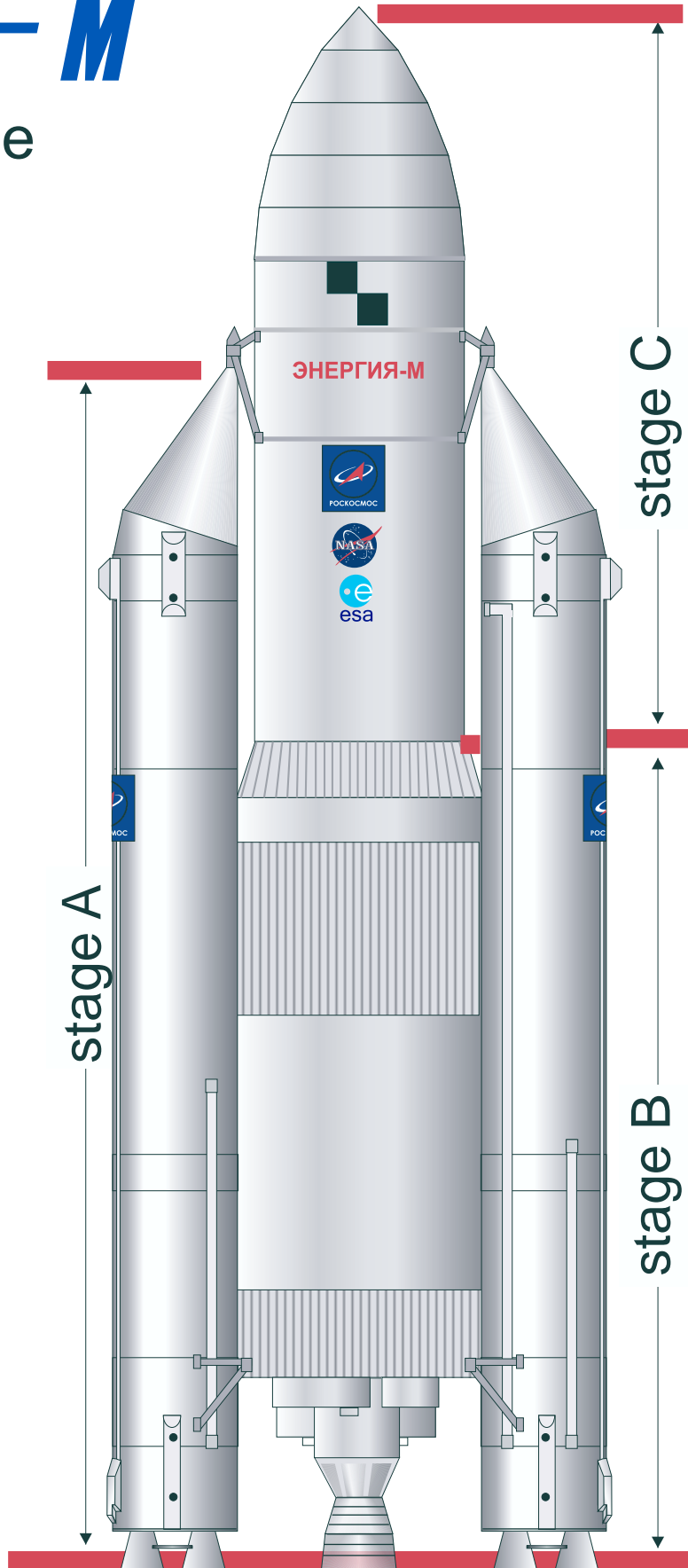

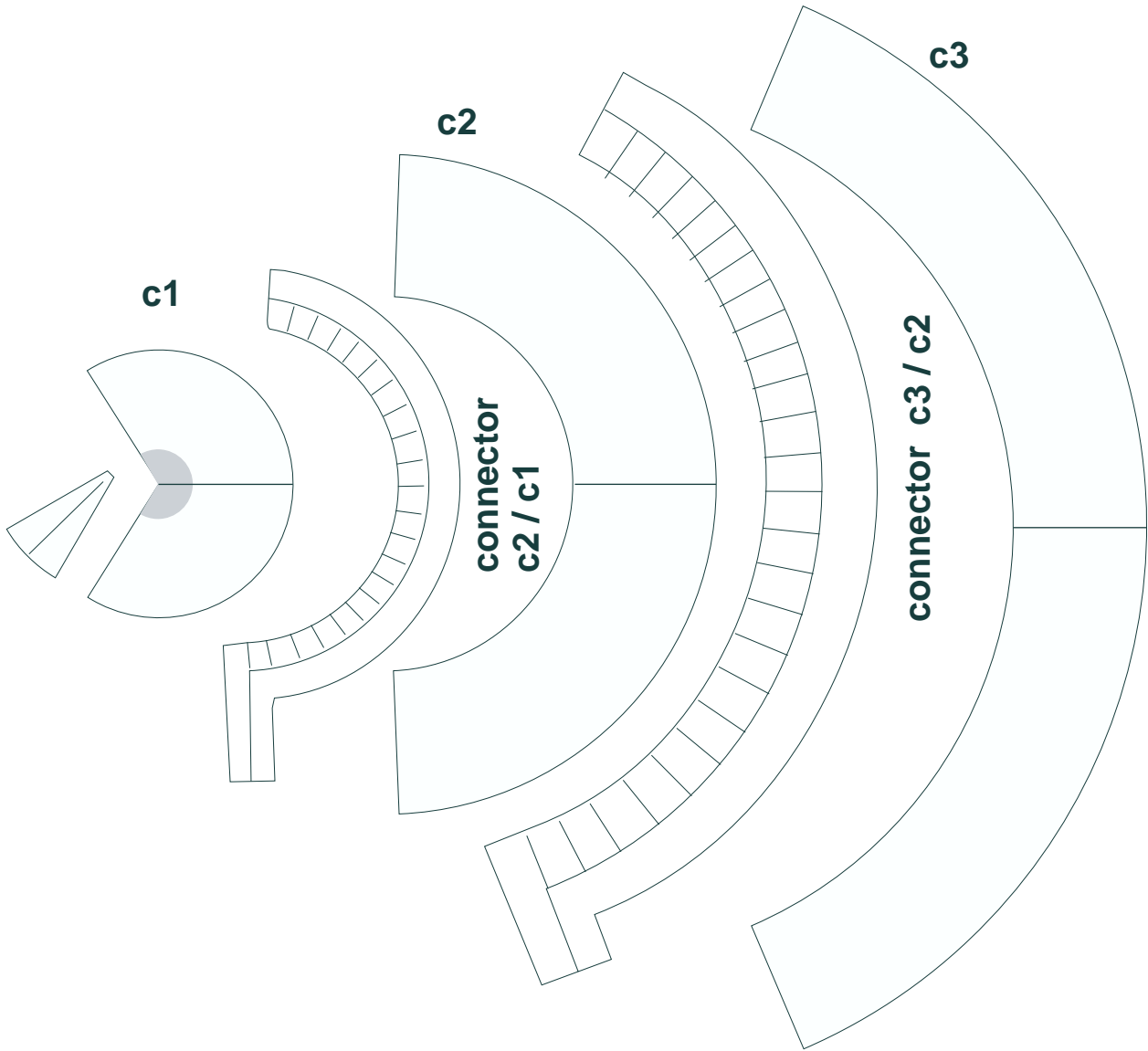

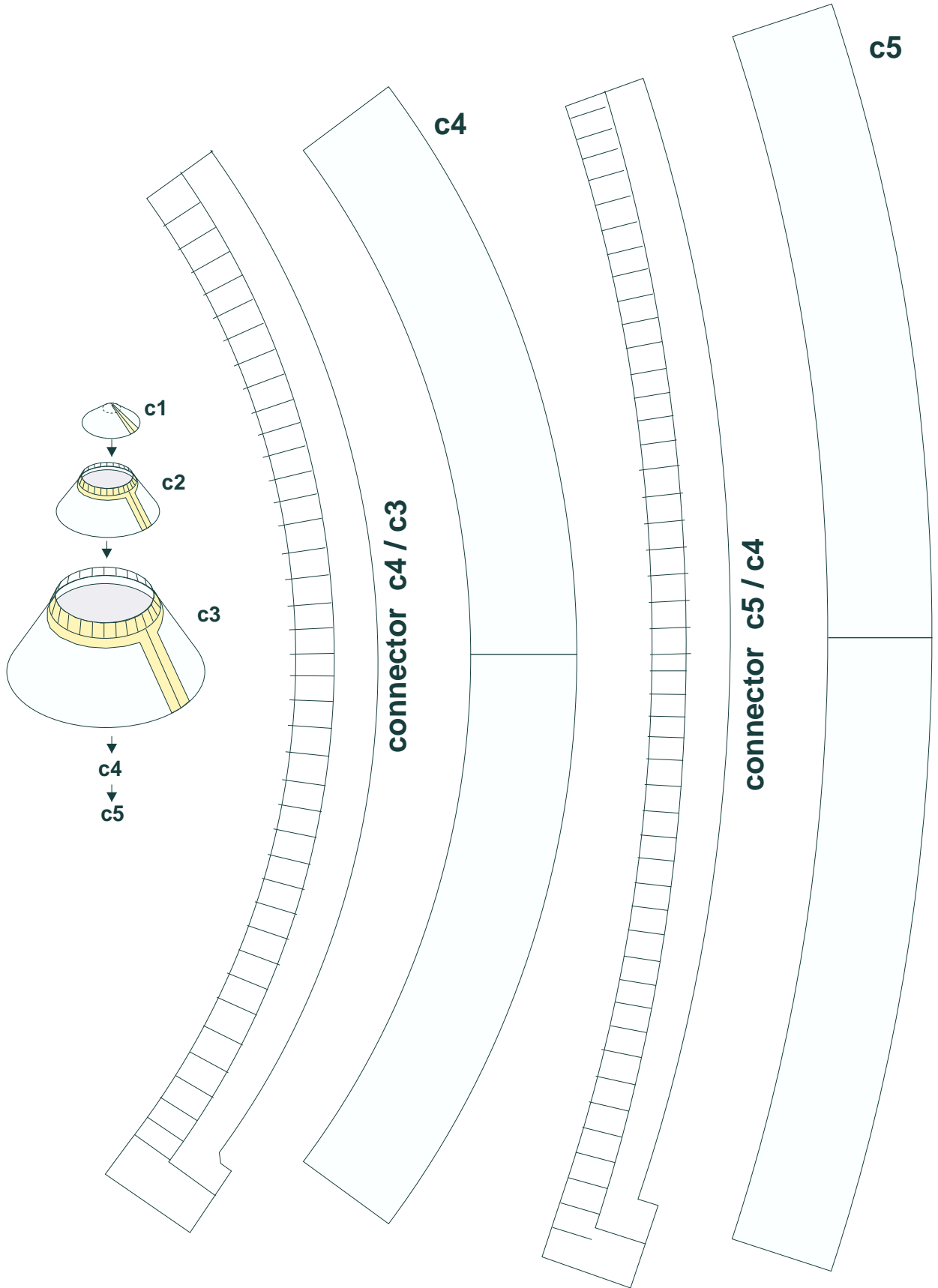

10 cm

c10

10 cm

front line →

c6

**ЭНЕРГИЯ - М**

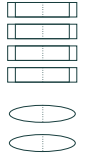
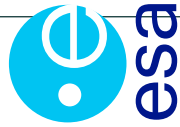
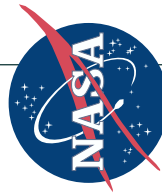

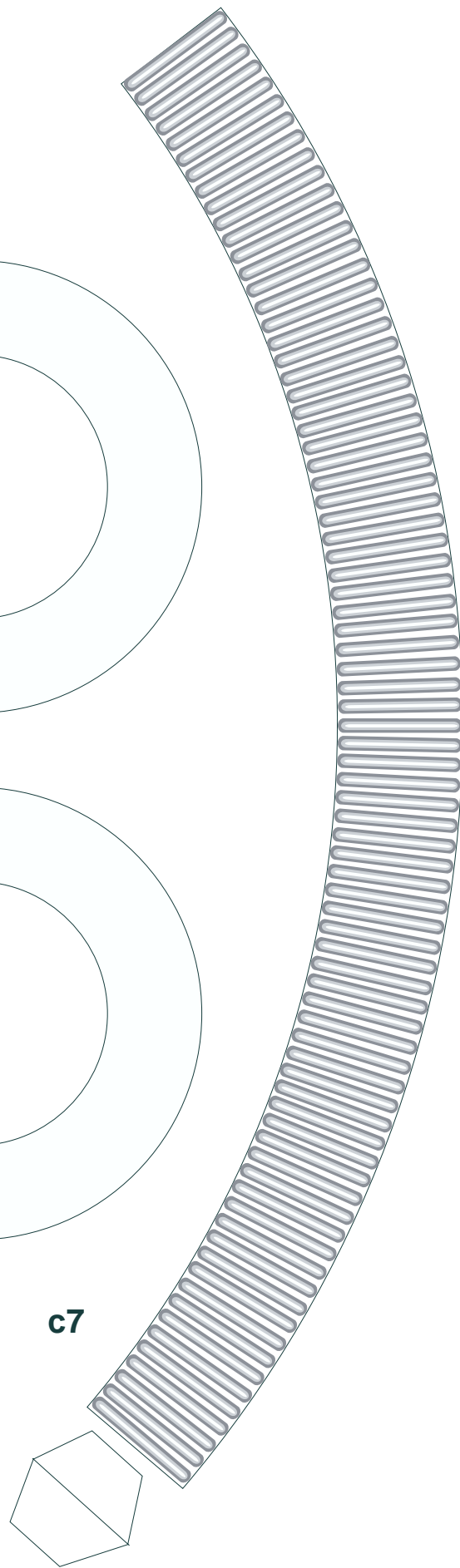
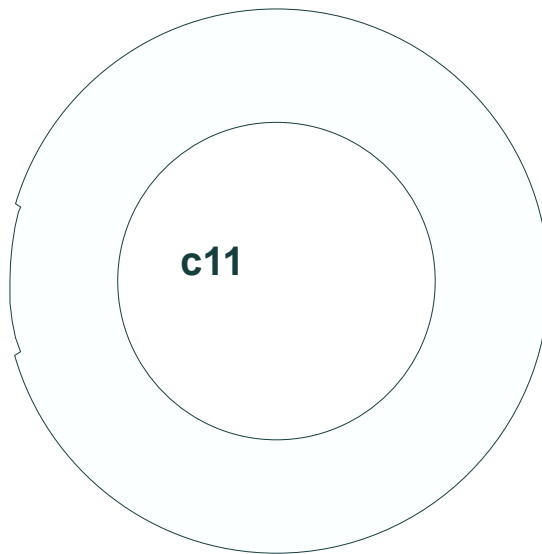
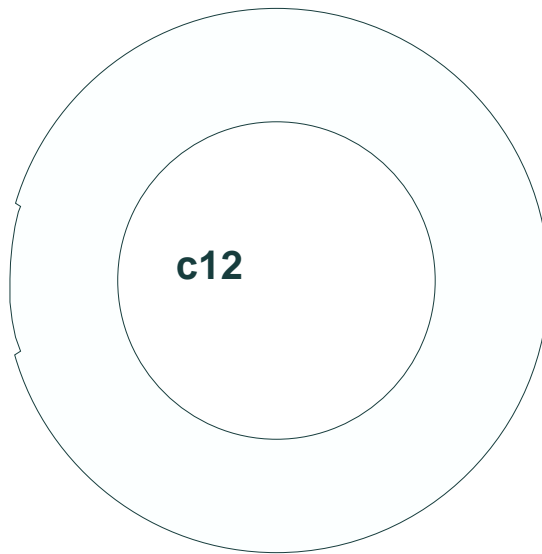
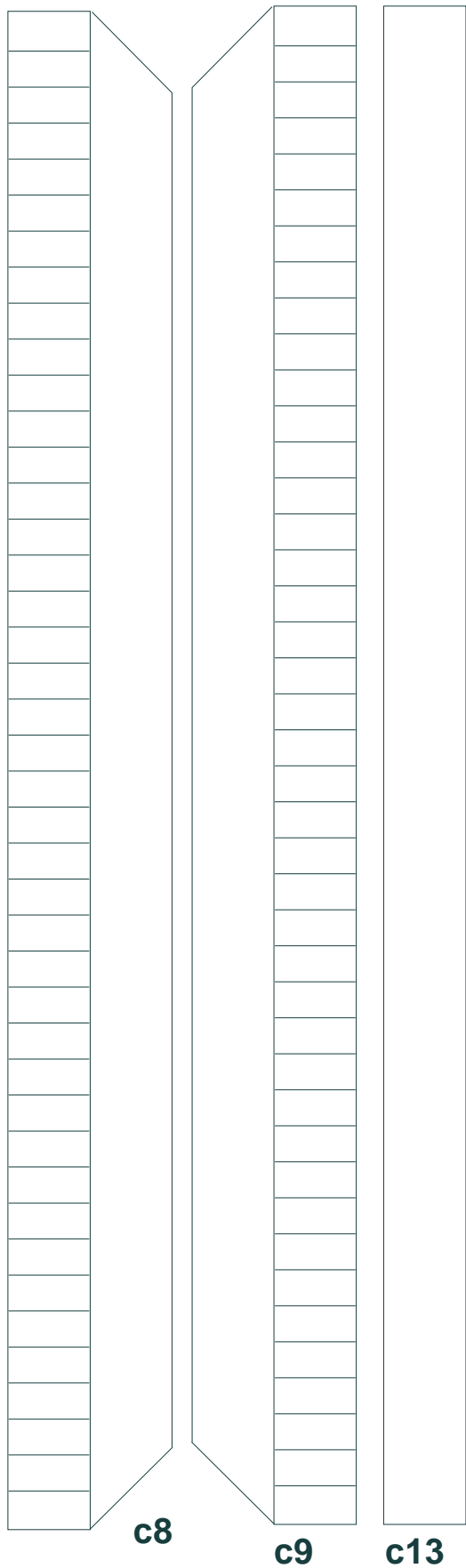

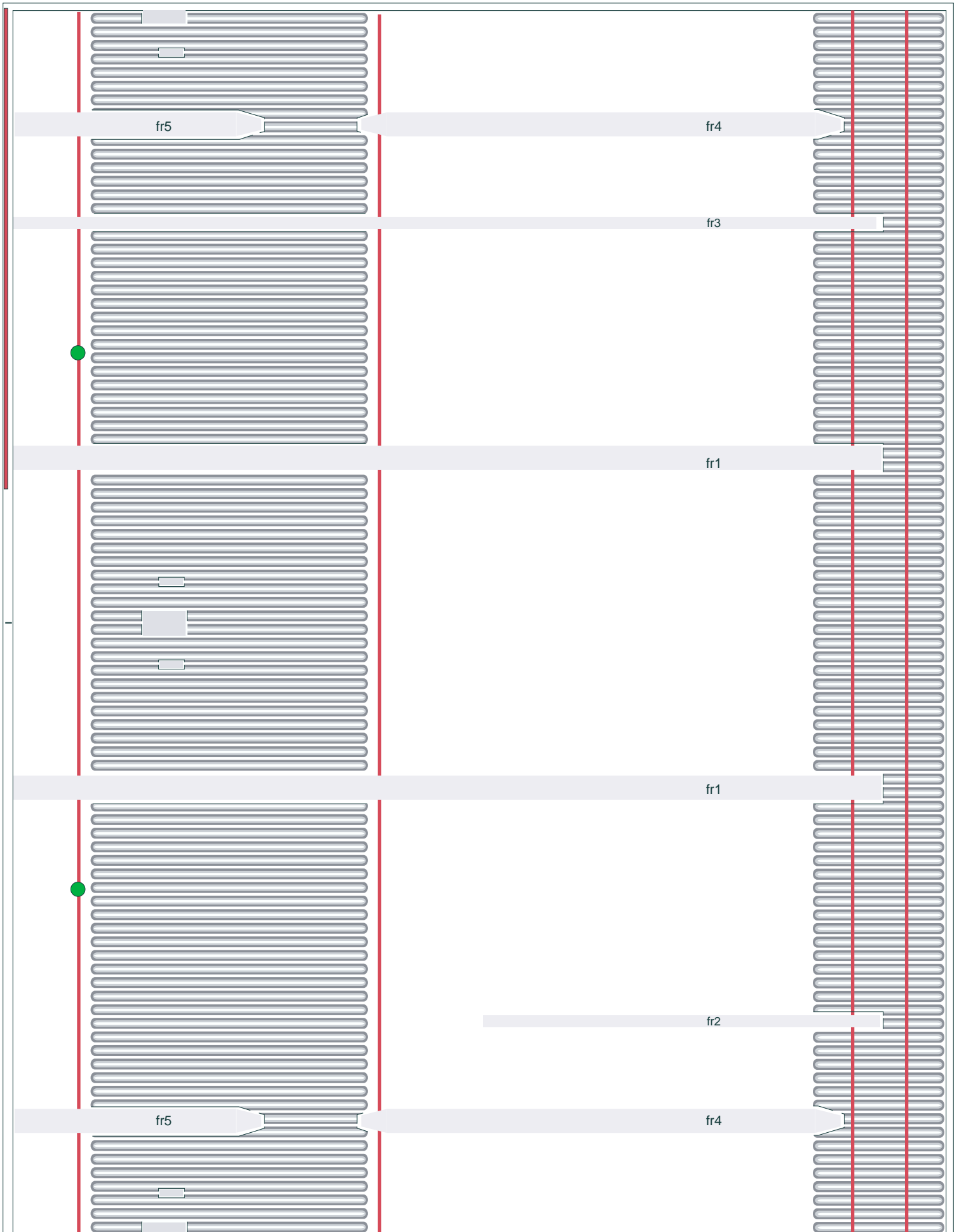

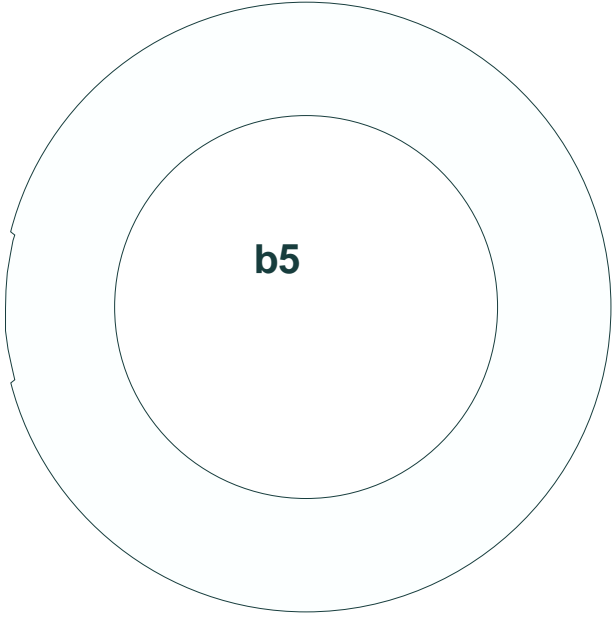
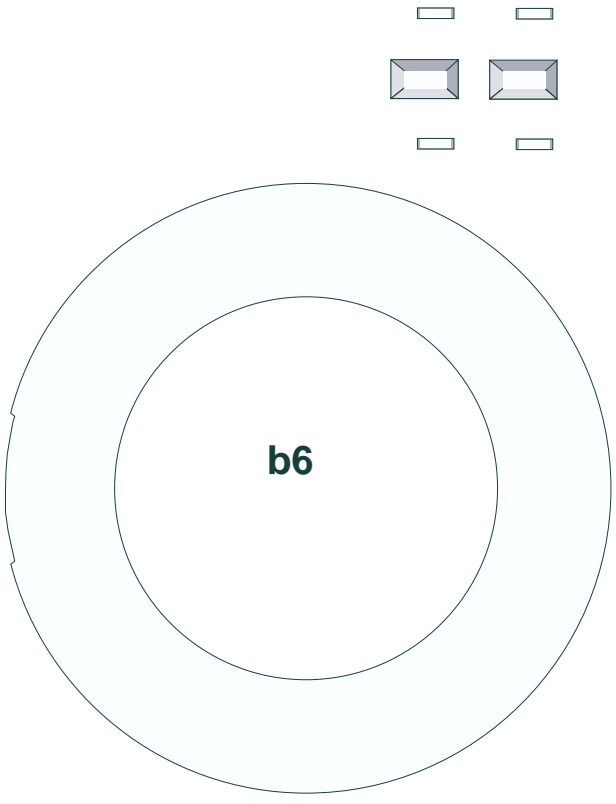
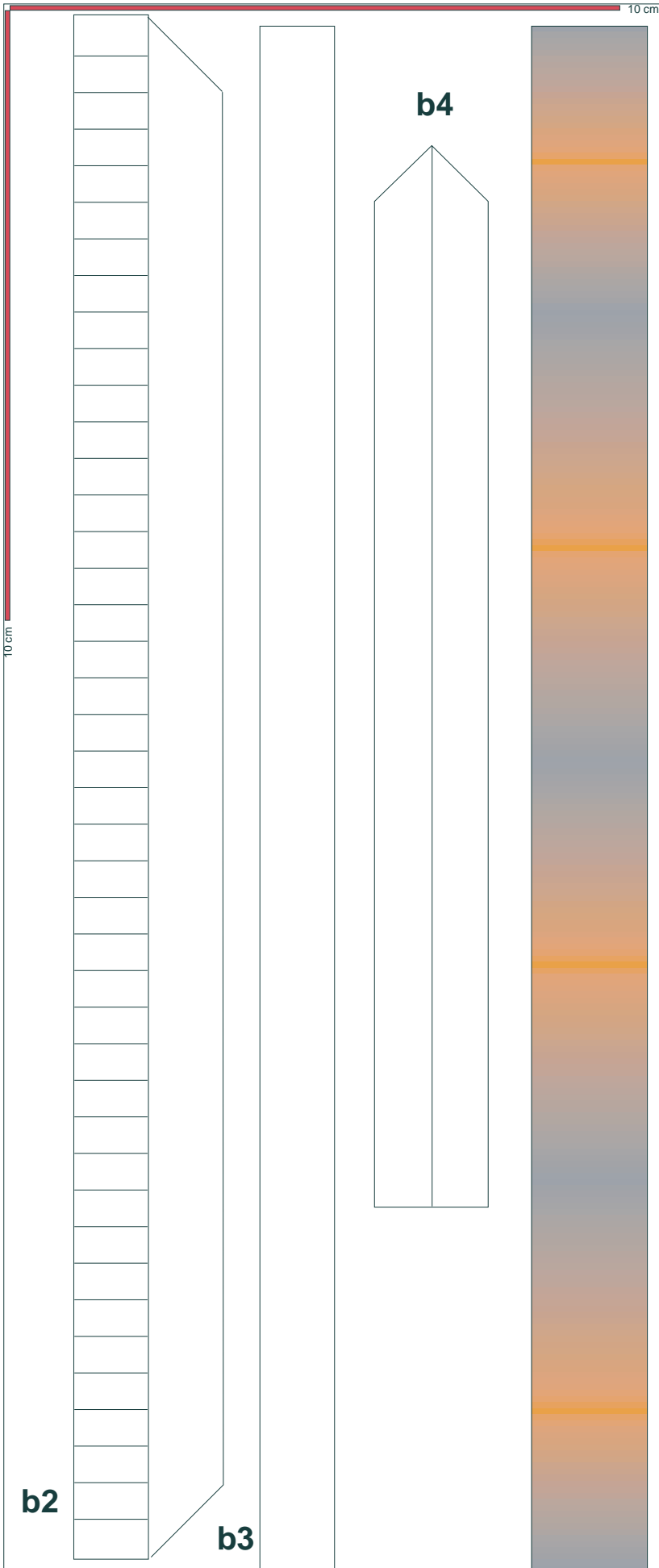

**b8**

**print on cardstock**

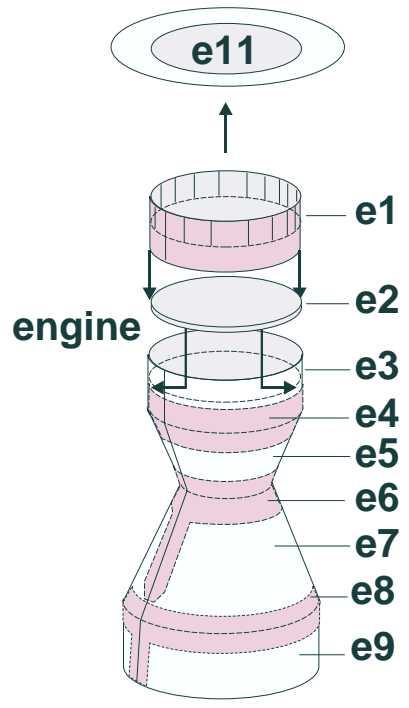
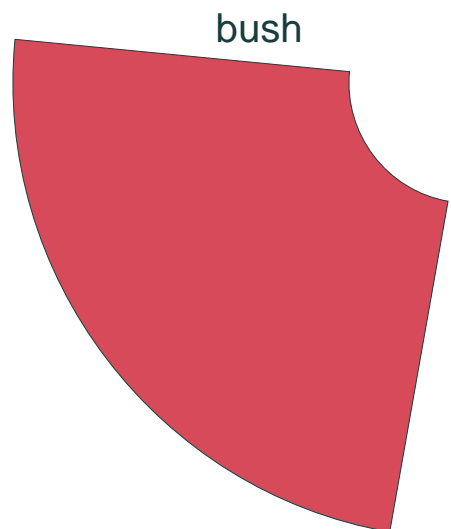
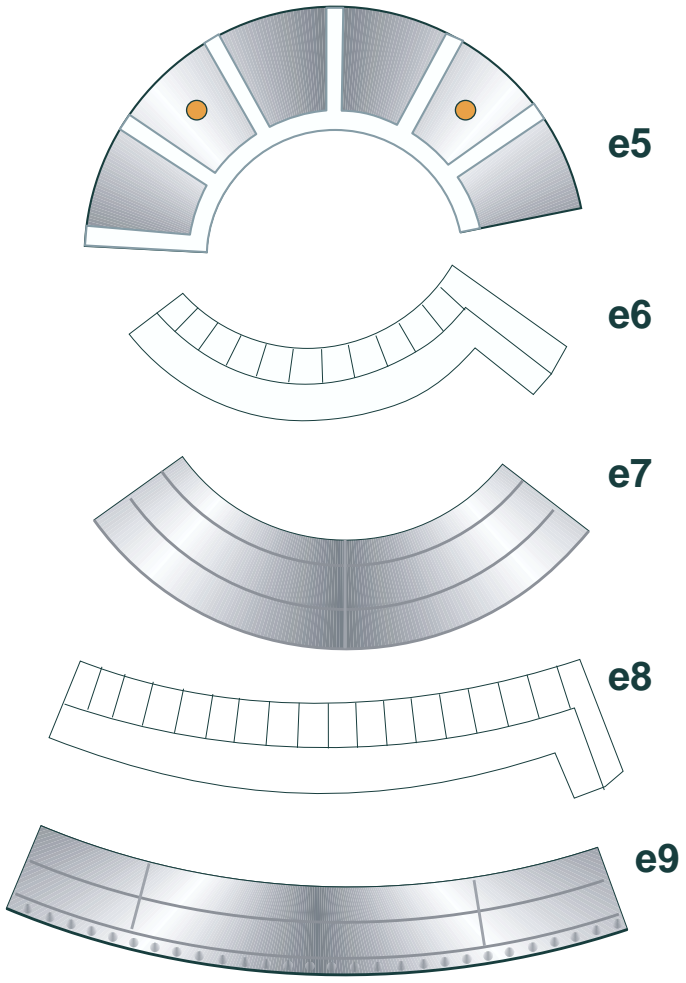
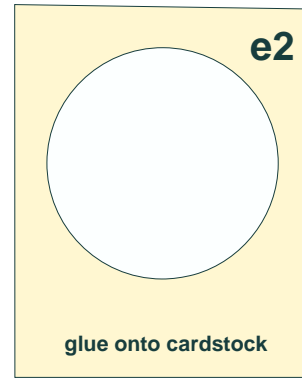
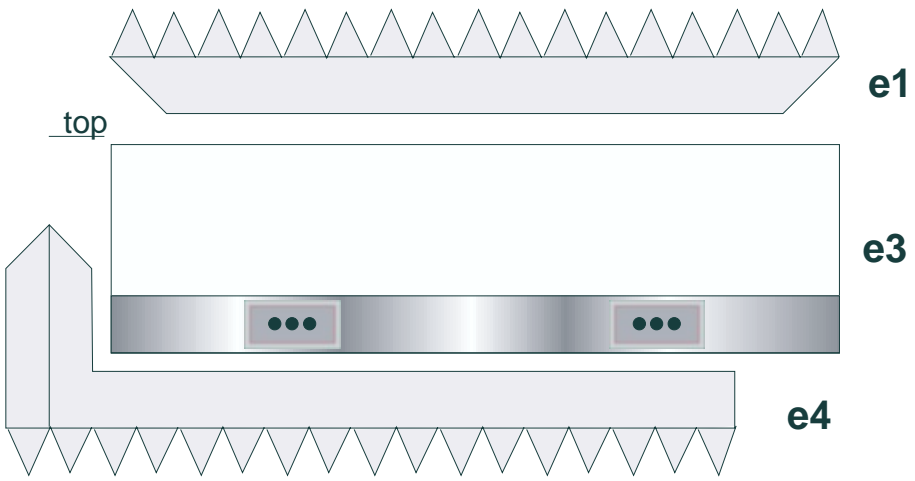



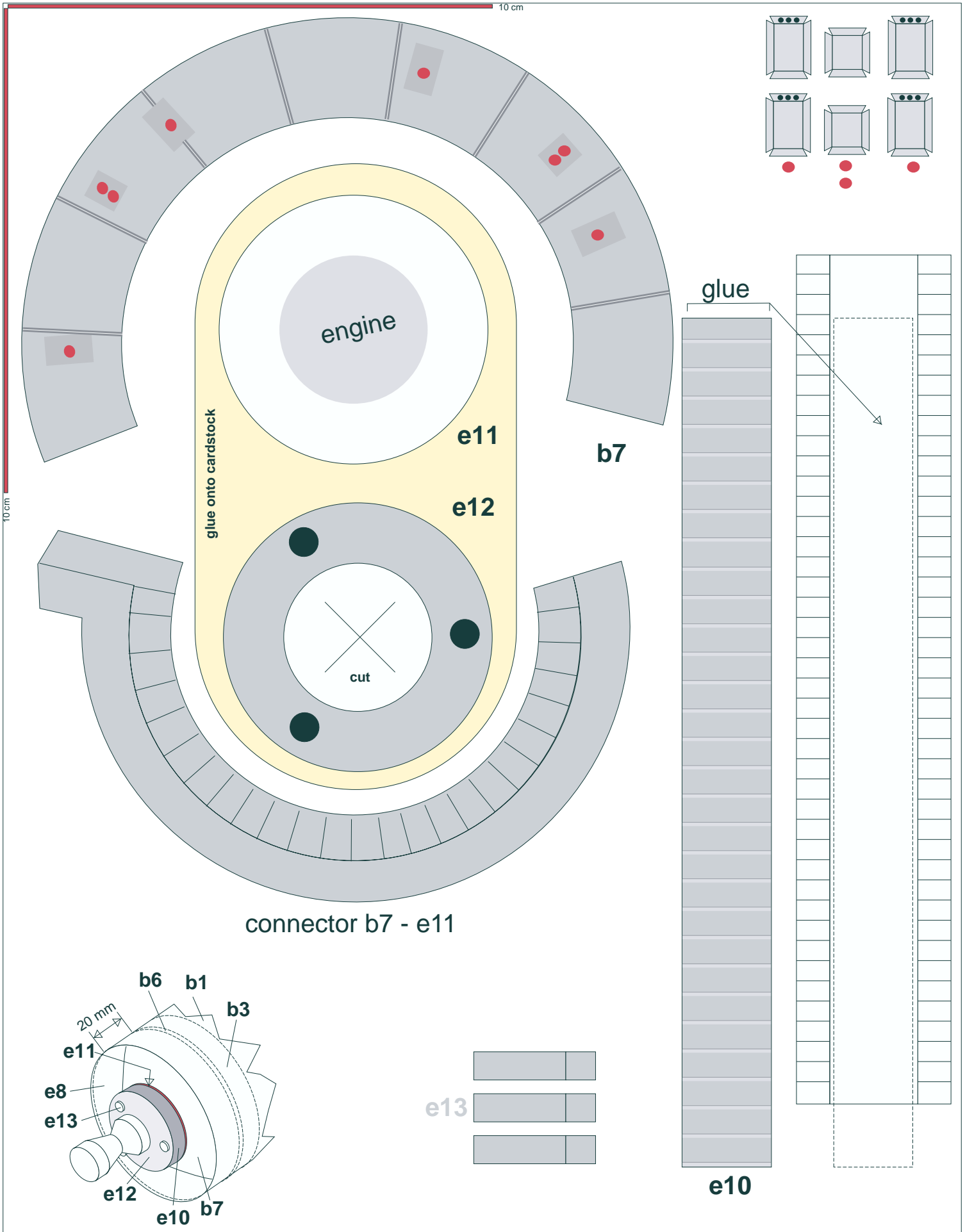

option

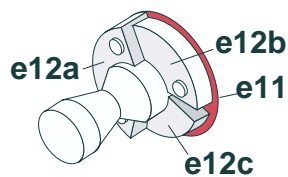
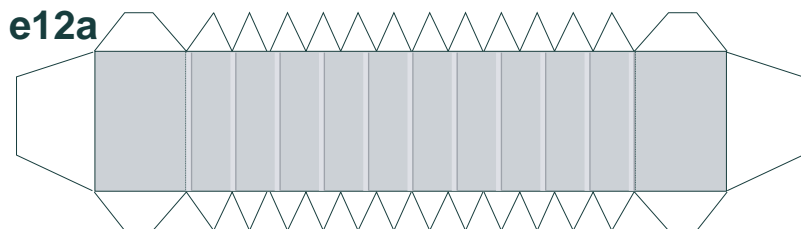
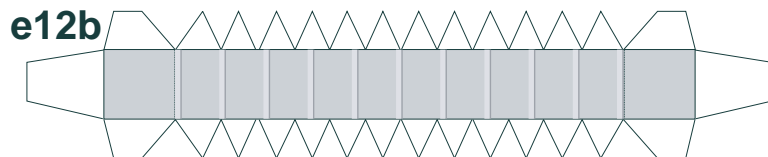
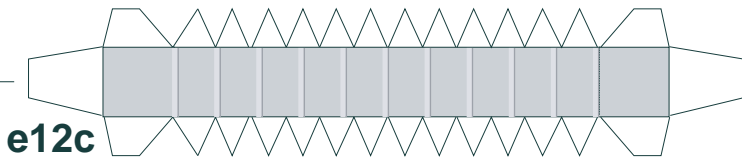
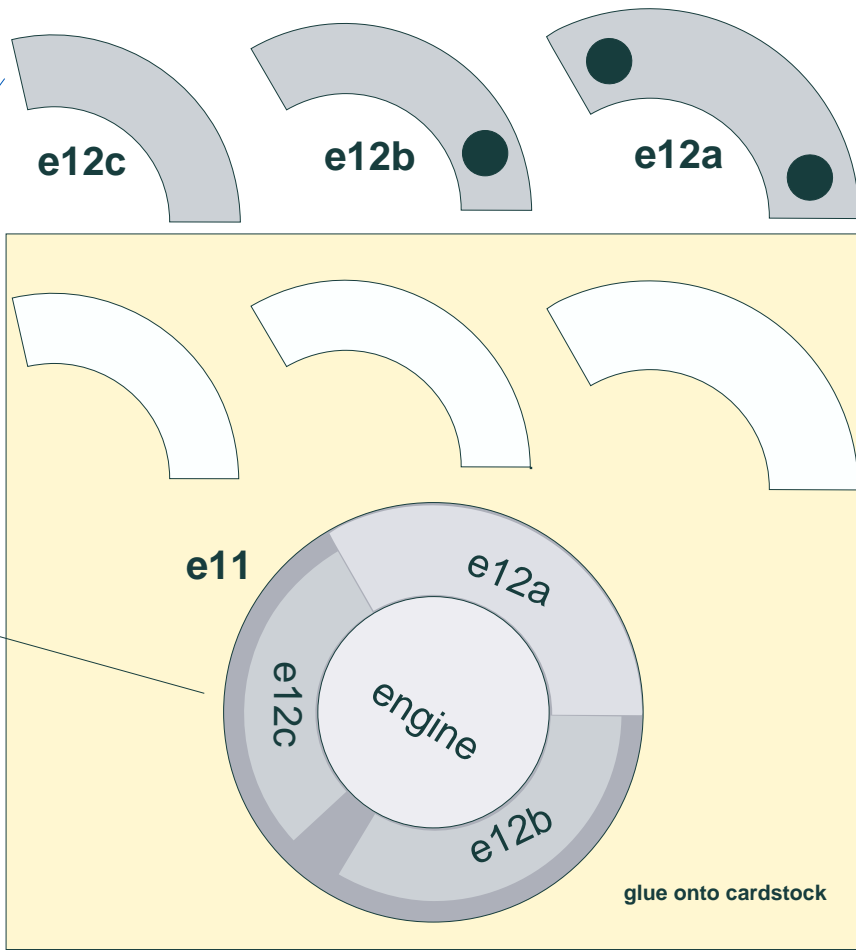

first glue engine  
on e11  
then glue e12a,b,c

### Stage B fairings

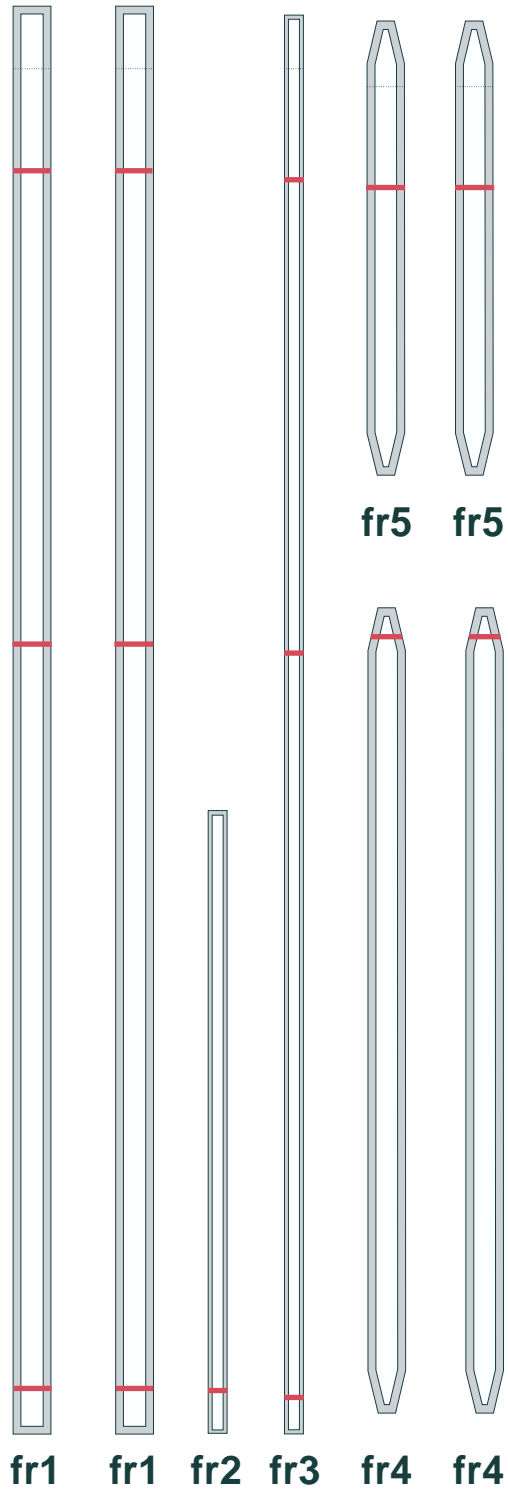

a13

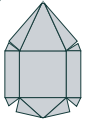

a5  
a3a



a13 right

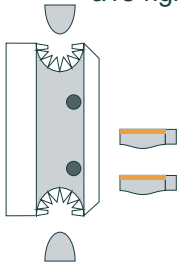

a13 left

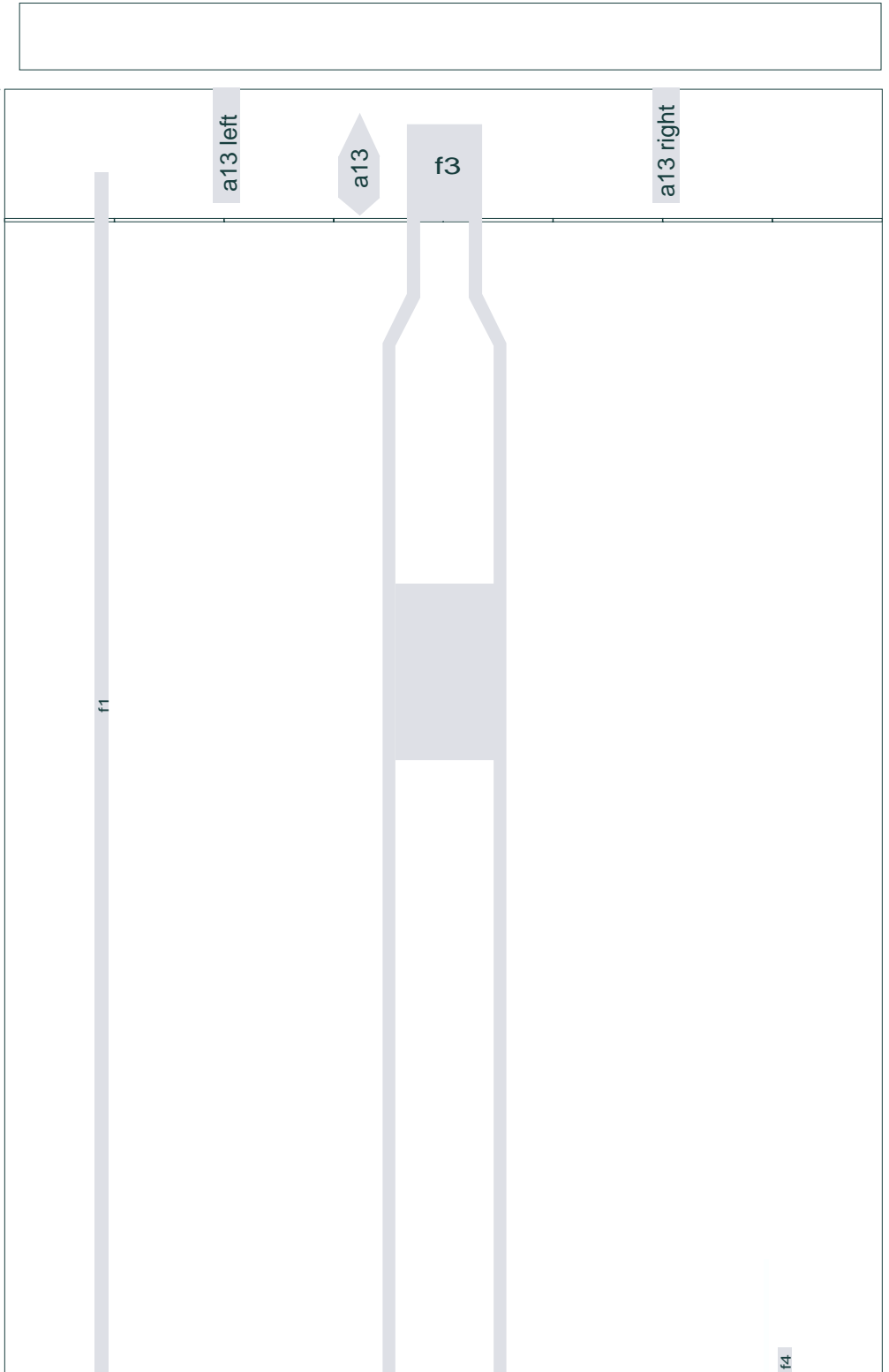
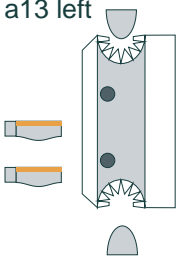

a4

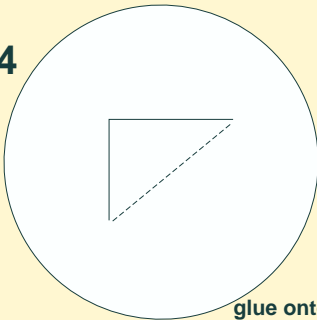

a7

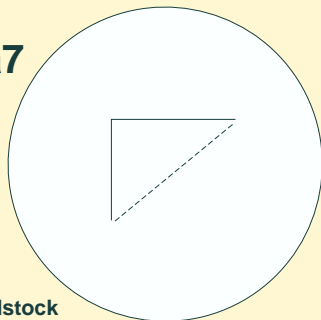

glue onto cardstock

A1 left



a3b

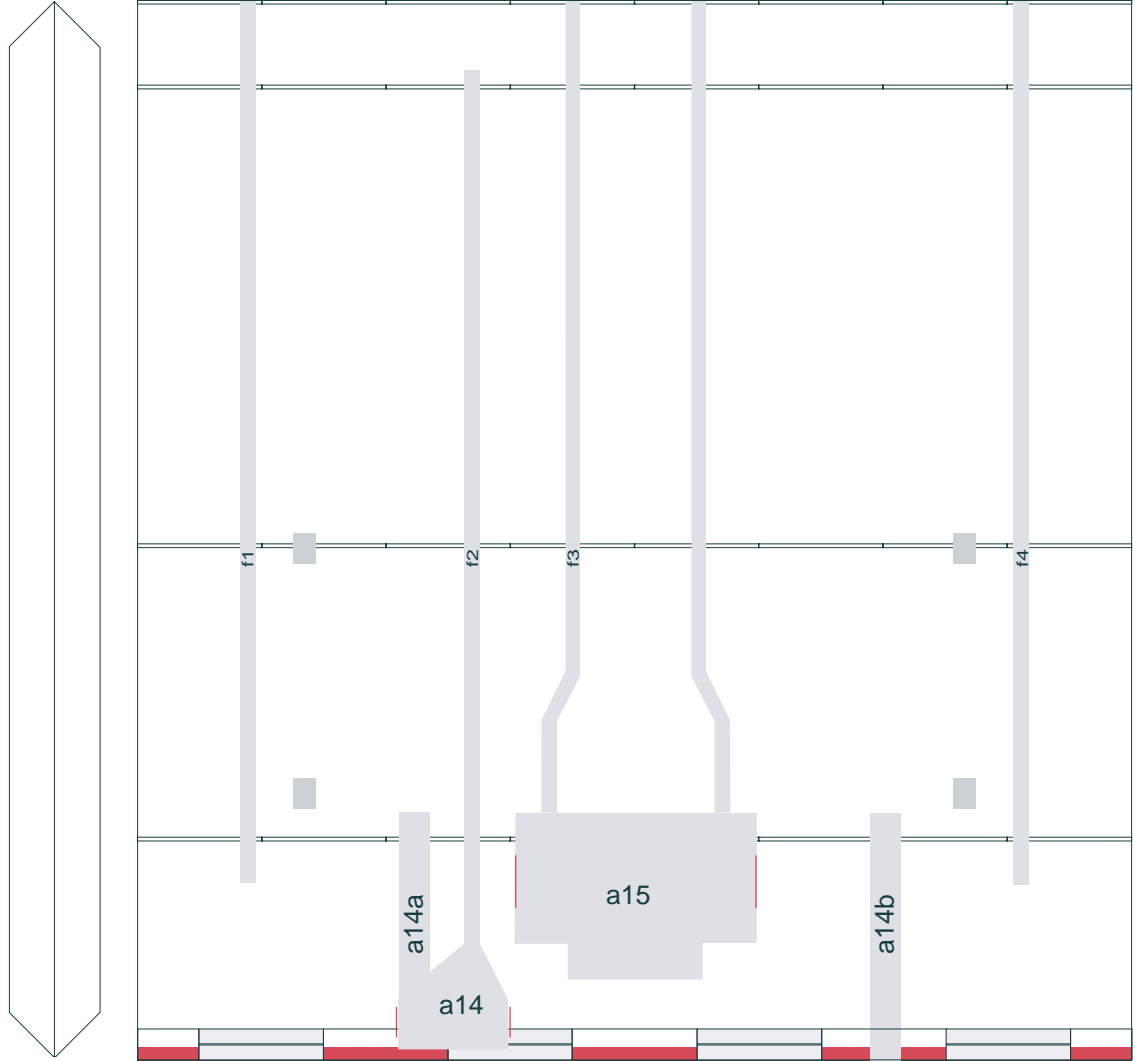

a14a

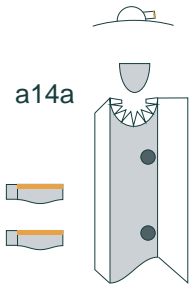

a14

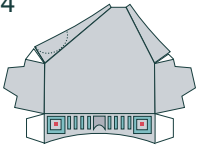

a14b

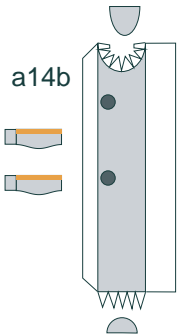

a9

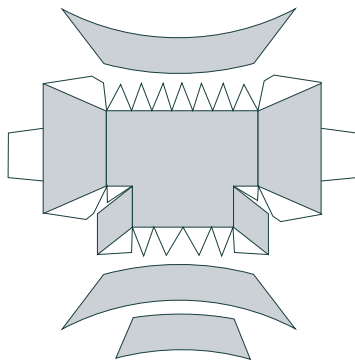
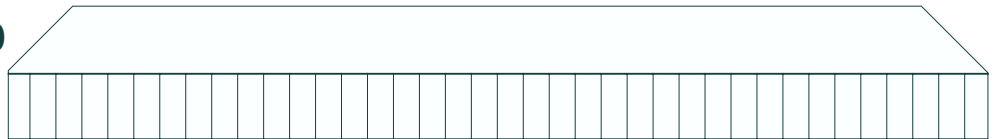

a15a

a15

a15b

a15c

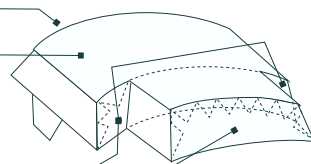

← slots

**A1 left**

a13

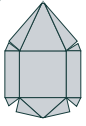

a5

a3a

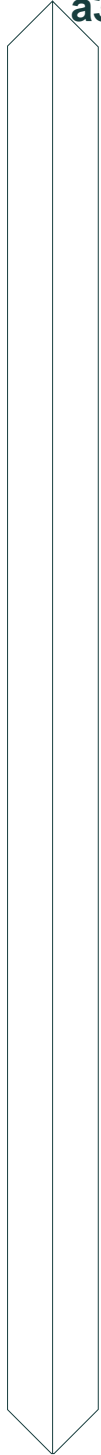

a13 right

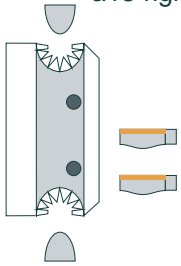

a13 left

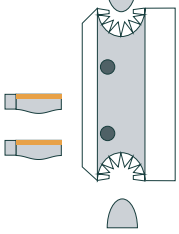

10 cm

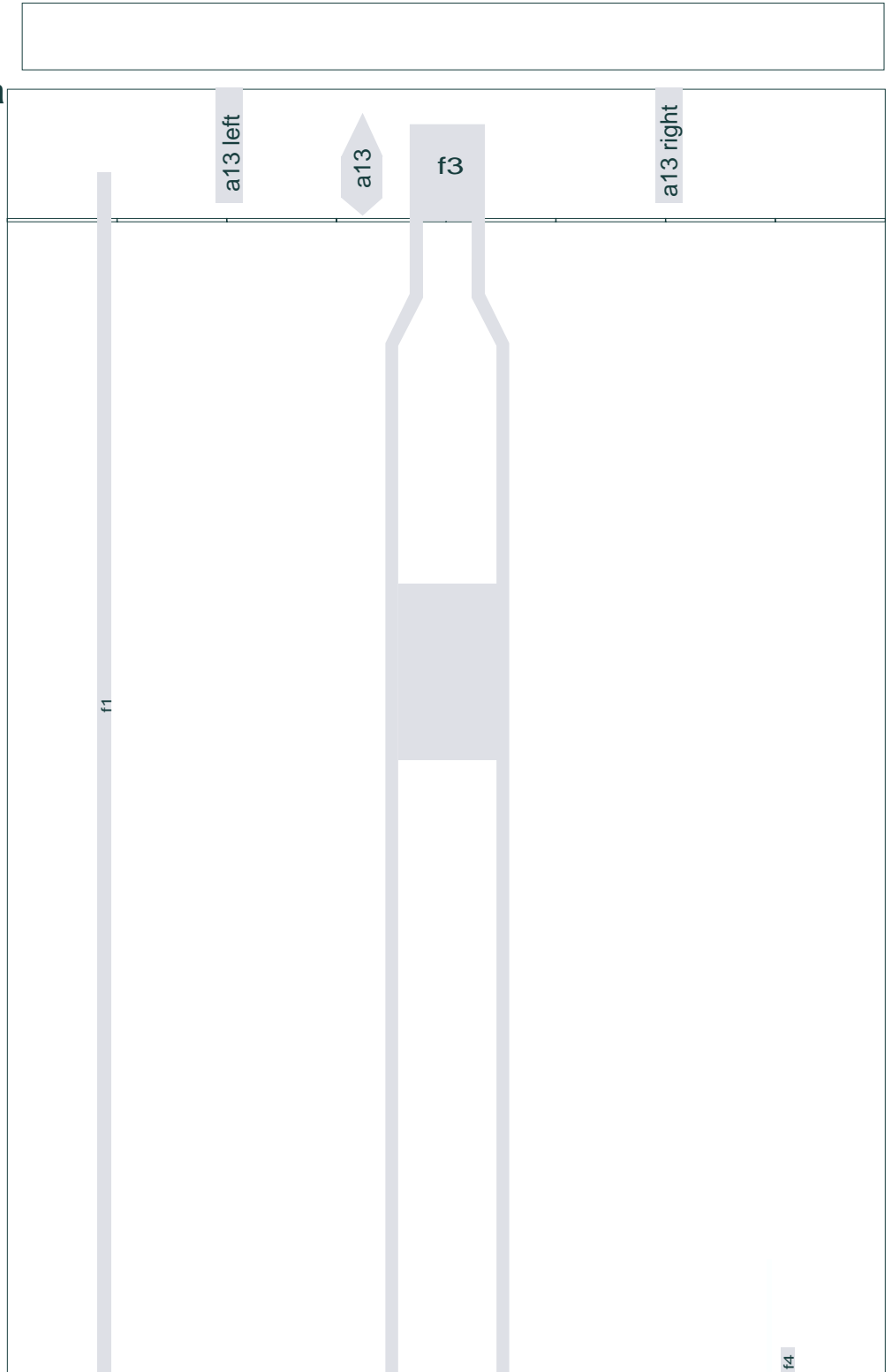

a4

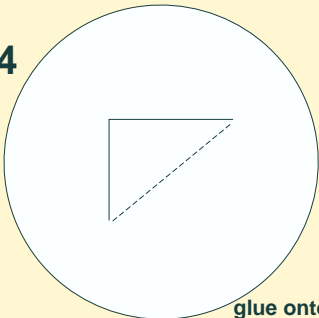

a7

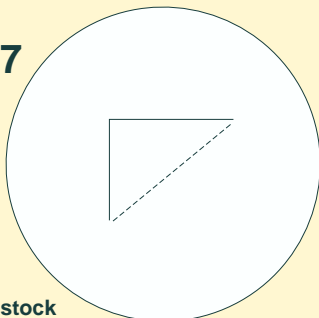

glue onto cardstock



right

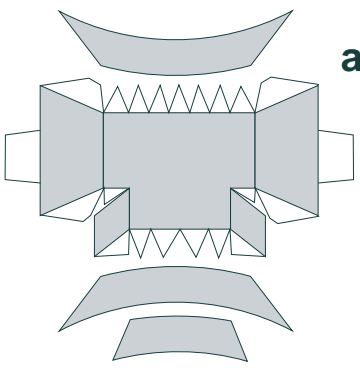
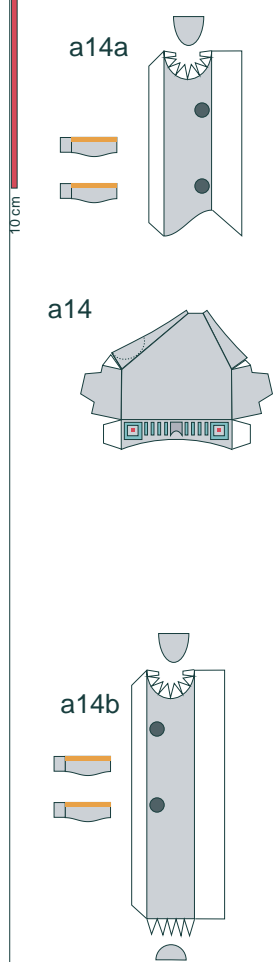
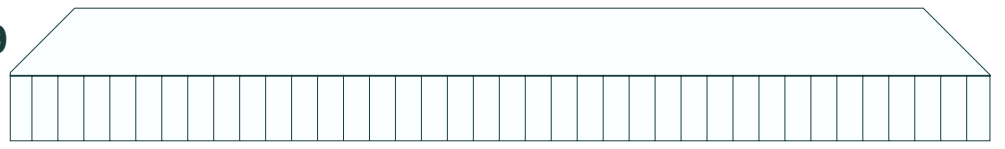
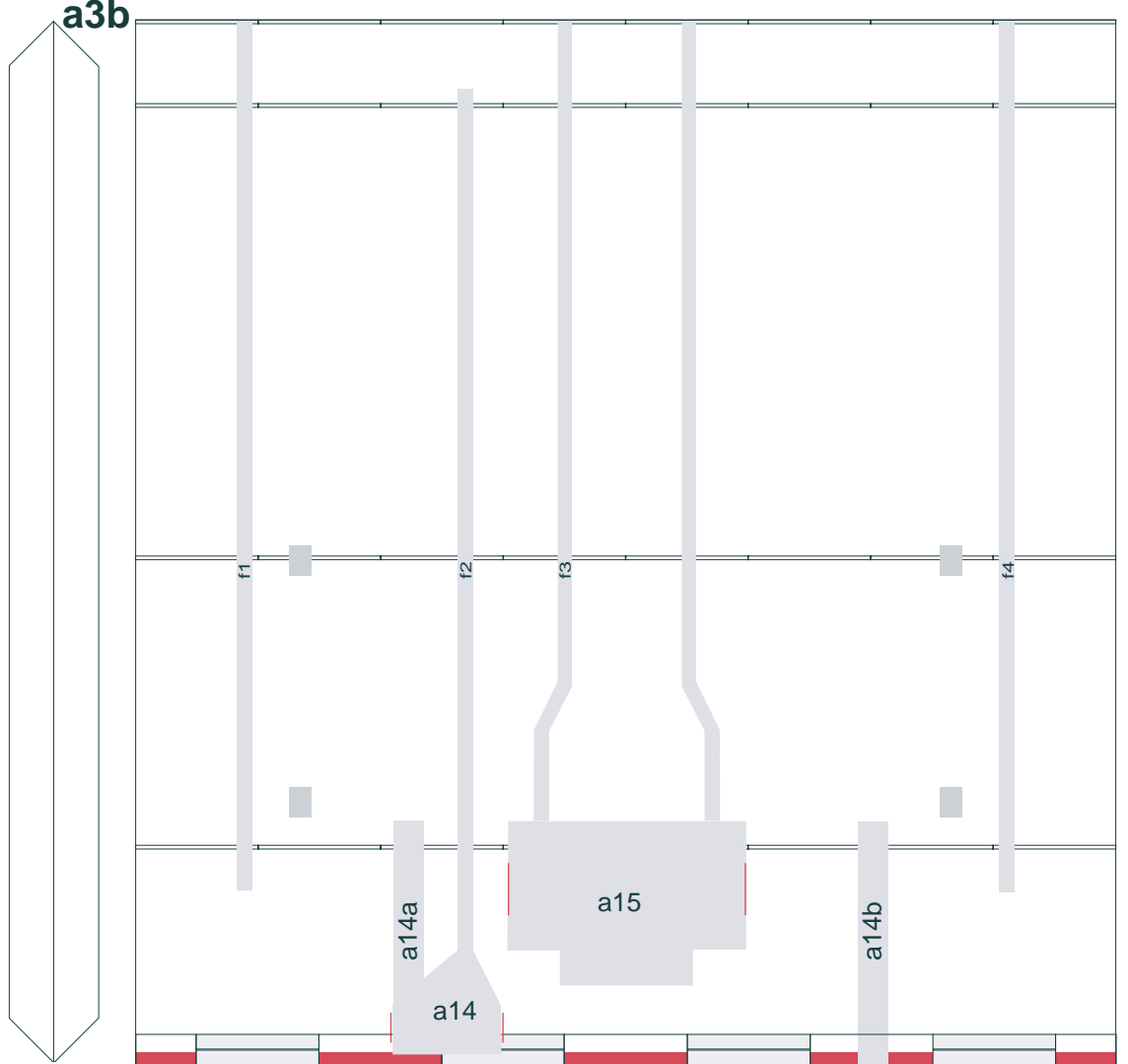

← slots

A2 right

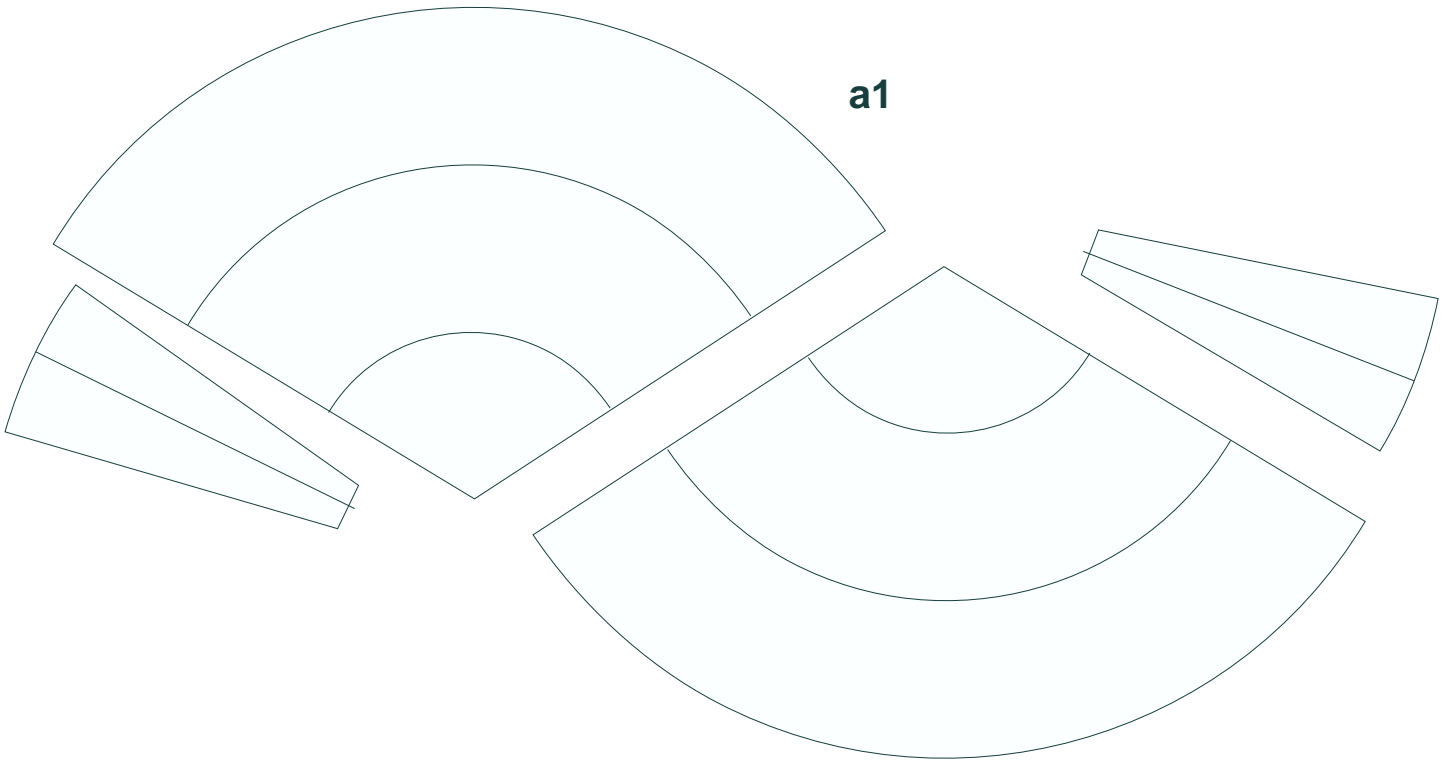
**a1****a2**

top

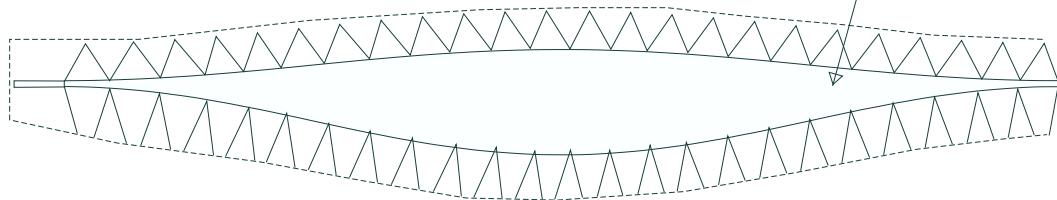
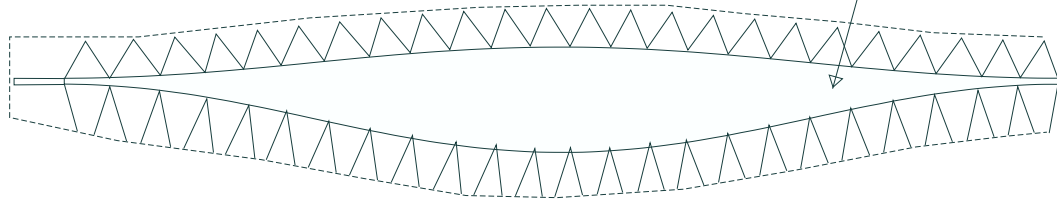
**a2-bs**

Glue part a2 onto a2-bs and immediately (before glue dry up) roll as semitubes. Take it by hard cylinder on soft (porous) surface from back side. Then glue a2 as a tube. Cut toothing only on dry one.



# Stage A fairings

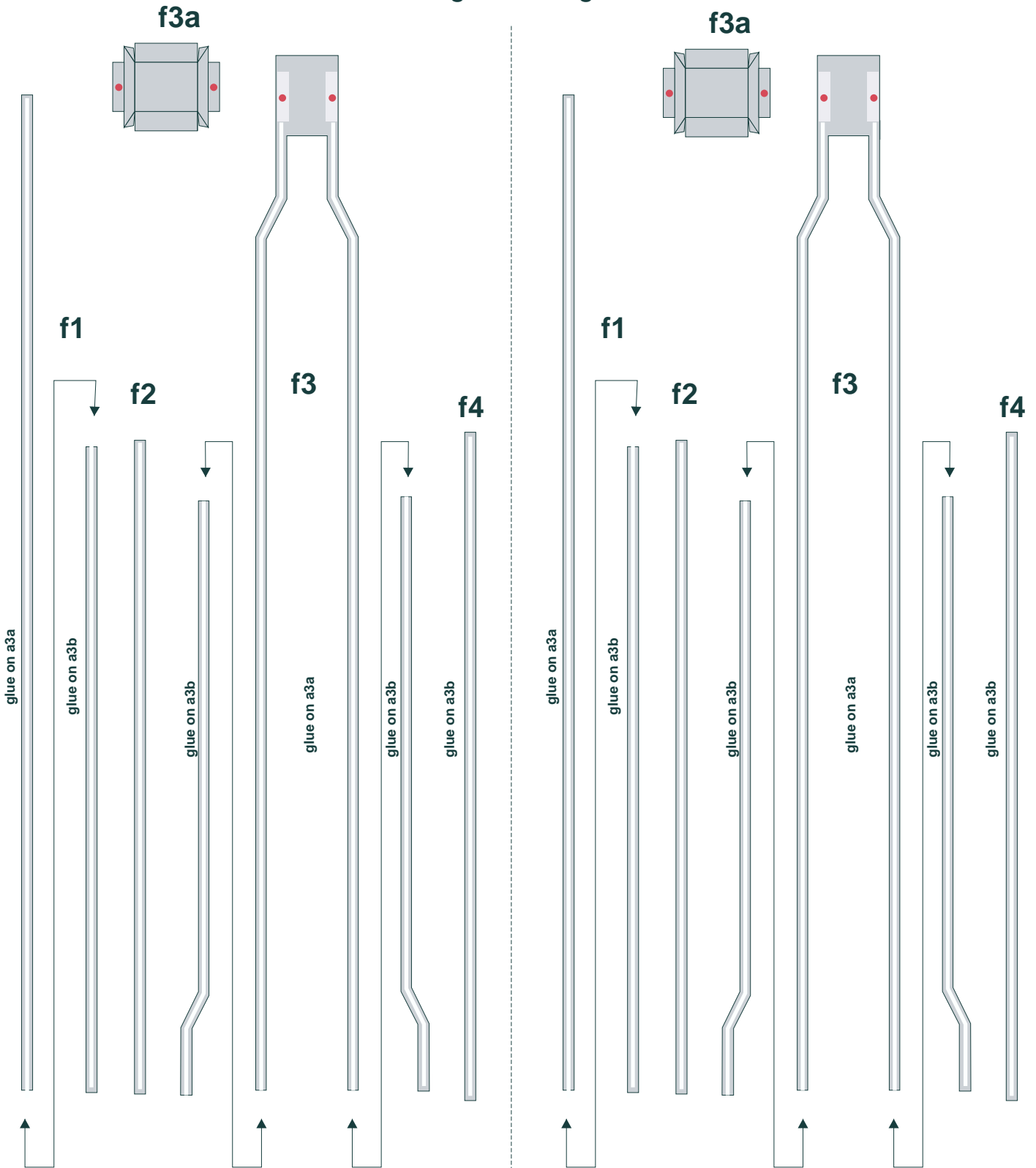

a11

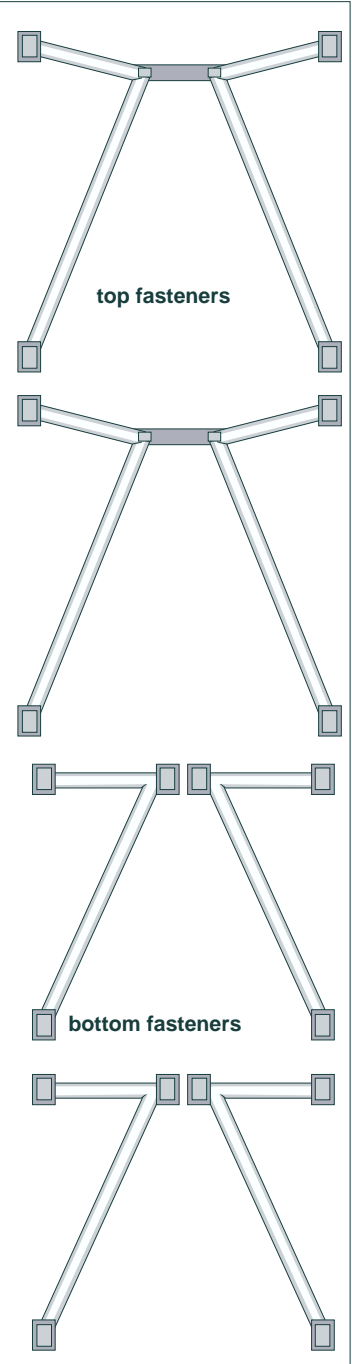
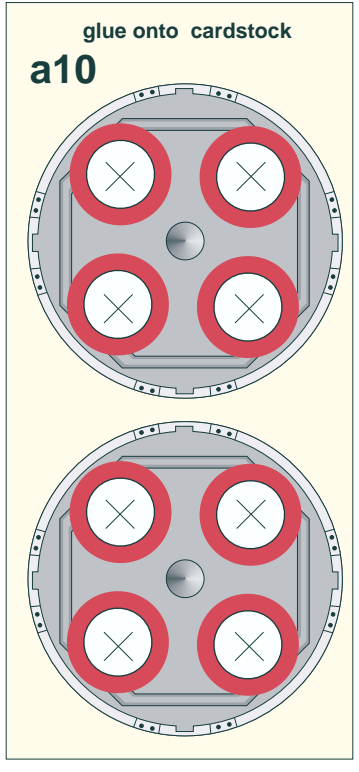
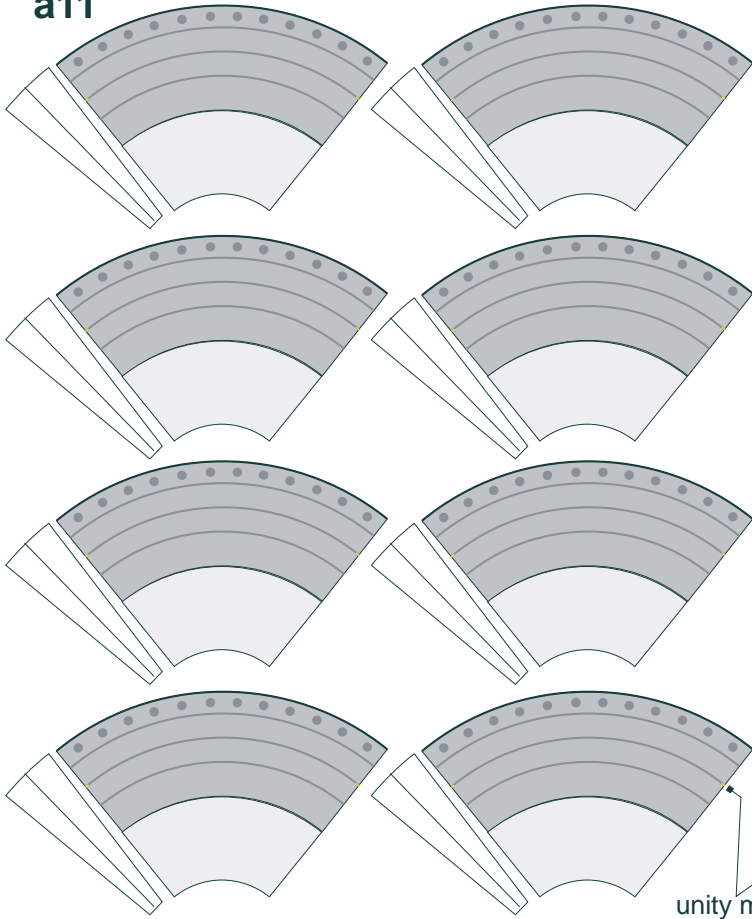

bushes

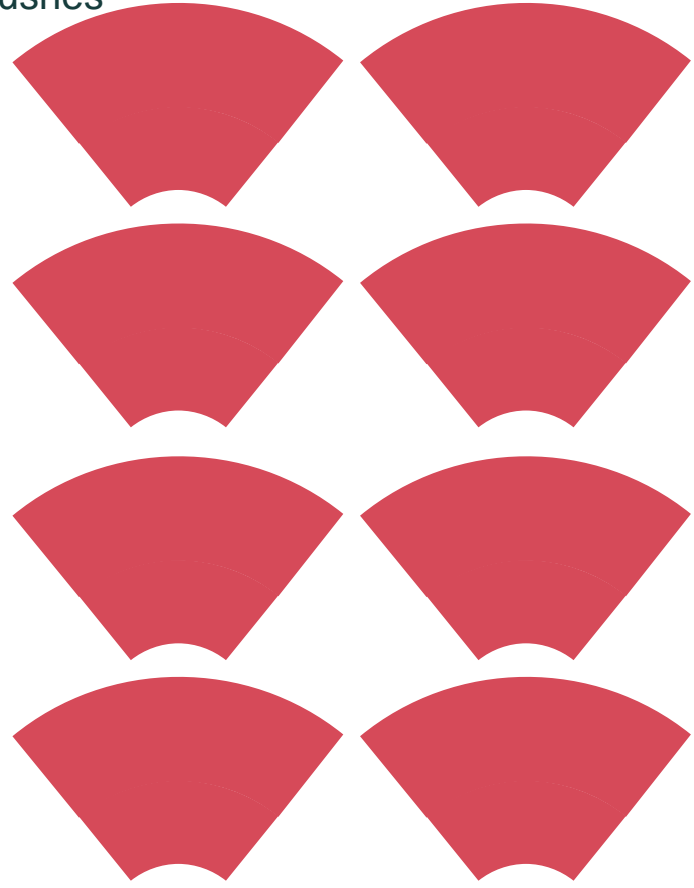

unity marks

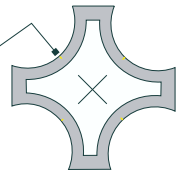

a10a

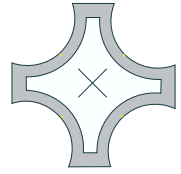

glue onto paper

a12

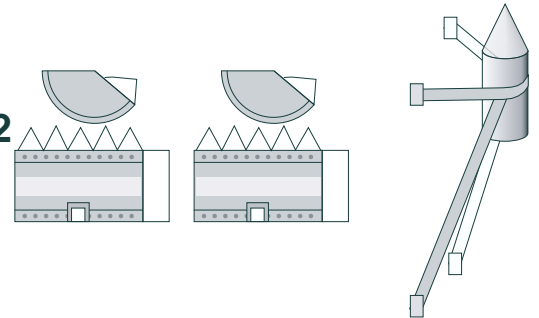

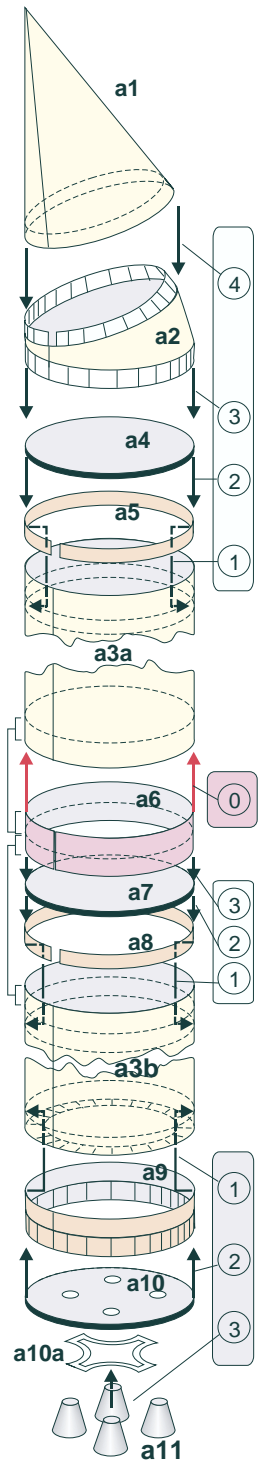

# steps of assembling parts of stage A body

 supporting rings  
 connecting ring

← last step of assembling body of stage A

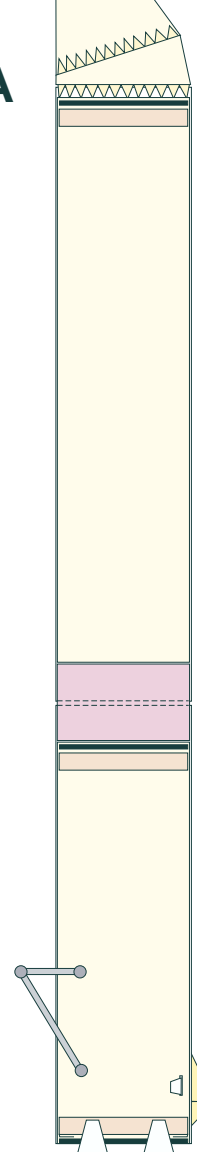
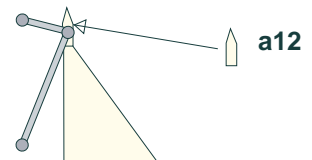

bushes for inserting into the nozzles

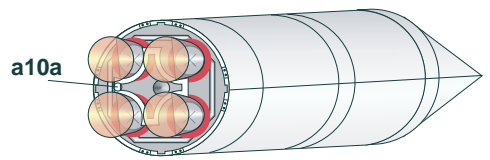
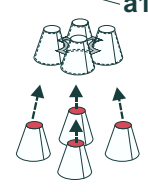

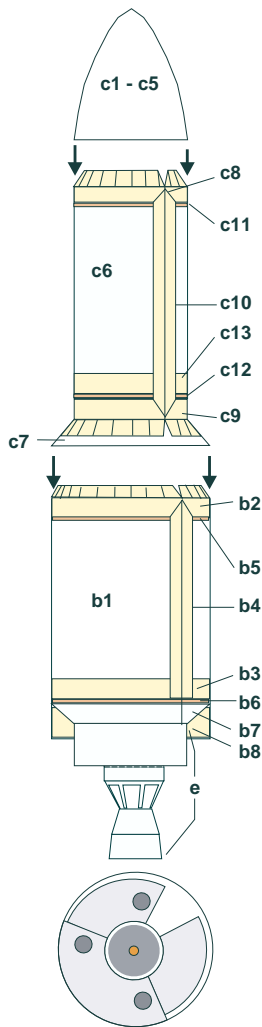

**assembling parts of stages B and C**

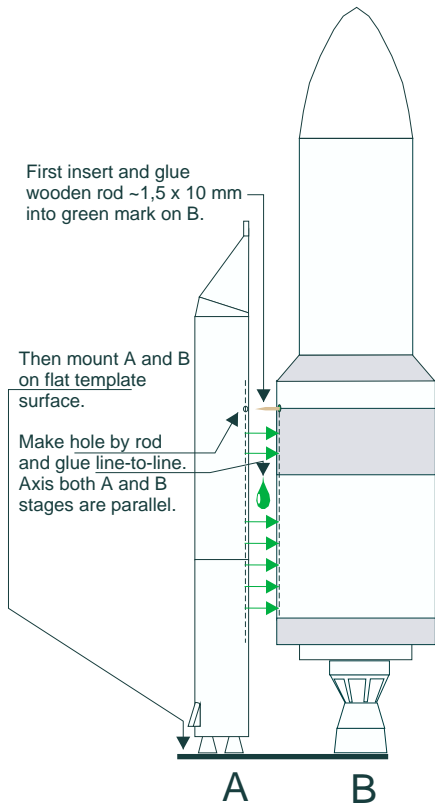

**assembling of stages A and B**

